

Please cut where indicated and insert the label into the plastic pocket on the spine of the binder.

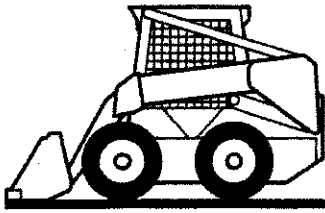

**SKID-STEER
LOADER
REPAIR**

L465, Lx465, Lx485

Vol. 1
86587274

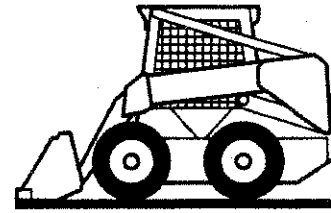

**SKID-STEER
LOADER
REPAIR**

L465, Lx465, Lx485

Vol. 1
86587274



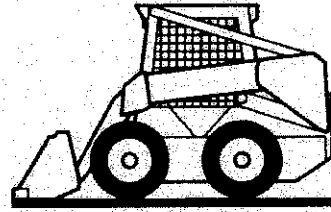

NEW HOLLAND

L465

Lx465

Lx485

**Section 1 -
General Information**

**REPAIR
MANUAL**

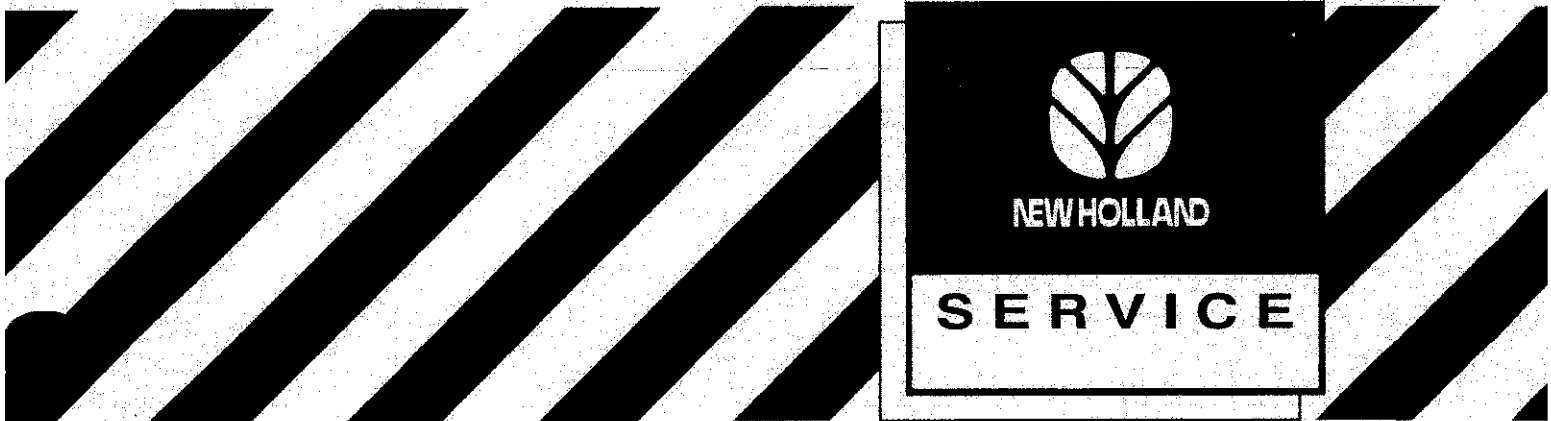

L465, Lx465, Lx485 SKID-STEER LOADER REPAIR MANUAL CONTENTS



SECTION 1 - GENERAL INFORMATION

SECTION 2 - ENGINE

SECTION 3 - ELECTRICAL SYSTEM

SECTION 4 - FINAL DRIVE, AXLES, BRAKES

SECTION 5 - HYDROSTATIC SYSTEM AND STEERING SYSTEM

SECTION 6 - HYDRAULIC SYSTEM

SECTION 7 - SEAT, CAB, ROPS, BOOM LOCK, BOOM,
ATTACHMENT MOUNTING PLATE

SECTION 8 - OPTIONAL EQUIPMENT

SECTION 1

GENERAL INFORMATION

CONTENTS

INTRODUCTION	1-2
ABOUT IMPROVEMENTS	1-2
SAFETY INFORMATION	
Precautionary Statements	1-3
Safety Precaution Information	1-4
Safety Decals	1-8
General Safety Information	1-11
MACHINE MODEL AND SERIAL NUMBER LOCATION	1-13
ENGINE MODEL AND SERIAL NUMBER LOCATION	1-13
HARDWARE TORQUE SPECIFICATIONS CHART	1-14
HYDRAULIC TUBE AND FITTING INSTALLATION	1-16
HYDRAULIC TUBE AND FITTING TORQUE SPECIFICATIONS ...	1-16
PROPERLY SUPPORT A RAISED MACHINE	1-17
PROPERLY SUPPORT BOOM ON BOOM LOCK PINS	1-17
MAJOR UNIT OVERHAUL	1-17
CAB AND BOOM TILT PROCEDURE	1-18
CRANING THE SKID-STEER LOADER	1-25
DRILLING HOLES IN OVERHEAD DASH	1-27
ADAPTING ATTACHMENTS REQUIRING 12V ELECTRICAL POWER	1-28
HYDRAULIC SYSTEM COMPATIBILITY	1-30
ACCESSORY RELAY AND ENGINE FUSE BLOCK	1-31
SPECIFICATIONS	1-32
INDEX	1-37

INTRODUCTION

This service manual provides the technical information needed to properly service and maintain the Models L465, Lx465, and Lx485 skid-steer loaders. Use it in conjunction with the operator's manual which is supplied with the loader. Keep both manuals available for ready reference.

The L___ designates a factory standard built unit.

The Lx___ designates a factory deluxe built unit. Options factory installed include work lights, taillights, and auxiliary boom hydraulics.

The L465, Lx465, and Lx485 have many similarities with the major differences being engine horsepower and lifting capacity.

Whenever working on New Holland equipment, left and right sides of the machine are determined by standing behind the unit, looking in the direction of travel.

The easiest and least time-consuming removal, disassembly, and reassembly procedures are detailed in the manual. Modifying these procedures is not recommended.

New Holland skid-steer loaders are designed with emphasis on safety for operator protection. However, careless and negligent operation can still result in serious injury to persons or damage to property. Be sure to read and follow all safety instructions in this manual.

Your New Holland dealer is interested in your obtaining the most from your investment and will be glad to answer any questions you may have about your loader. When major service is required, your dealer's staff of trained service technicians is ready to serve you.

When in need of parts, always order genuine New Holland service parts from your New Holland dealer. Be prepared to give your dealer the model and serial number of the engine and loader (the location of these numbers is described later in this section). Record the serial numbers here.

Loader Model _____

Loader Serial Number _____

Engine Model _____

Engine Serial Number _____



CAUTION: THIS SYMBOL IS USED THROUGHOUT THIS BOOK WHENEVER YOUR OWN PERSONAL SAFETY IS INVOLVED. TAKE TIME TO BE CAREFUL!

ABOUT IMPROVEMENTS

New Holland is continually striving to improve its products. We must, therefore, reserve the right to make improvements or changes when it becomes practical and possible to do so, without incurring any obligation to make changes or additions to the equipment sold previously.

ALL SPECIFICATIONS ARE SUBJECT TO CHANGE WITHOUT NOTICE.

PRECAUTIONARY STATEMENTS PERSONAL SAFETY

Throughout this manual and on machine decals, you will find precautionary statements ("CAUTION", "WARNING", and "DANGER") followed by specific instructions. These precautions are intended for the personal safety of you and those working with you. Please take the time to read them.



CAUTION: THE WORD "CAUTION" IS USED WHERE A SAFE BEHAVIORAL PRACTICE ACCORDING TO OPERATING AND MAINTENANCE INSTRUCTIONS AND COMMON SAFETY PRACTICES WILL PROTECT THE OPERATOR AND OTHERS FROM ACCIDENT INVOLVEMENT.



WARNING: THE WORD "WARNING" DENOTES A POTENTIAL OR HIDDEN HAZARD WHICH HAS A POTENTIAL FOR SERIOUS INJURY. IT IS USED TO WARN OPERATORS AND OTHERS TO EXERCISE EVERY APPROPRIATE MEANS TO AVOID A SURPRISE INVOLVEMENT WITH MACHINERY.



DANGER: THE WORD "DANGER" DENOTES A FORBIDDEN PRACTICE IN CONNECTION WITH A SERIOUS HAZARD.

FAILURE TO FOLLOW THE "CAUTION", "WARNING", AND "DANGER" INSTRUCTIONS MAY RESULT IN SERIOUS BODILY INJURY OR DEATH.

MACHINE SAFETY

Additional precautionary statements ("ATTENTION" and "IMPORTANT") are followed by specific instructions. These statements are intended for machine safety.

ATTENTION: The word "ATTENTION" is used to warn the operator of potential machine damage if a certain procedure is not followed.

IMPORTANT: The word "IMPORTANT" is used to inform the reader of something he needs to know to prevent minor machine damage if a certain procedure is not followed.



SAFETY PRECAUTION INFORMATION

UNSAFE OPERATING PRACTICES AND IMPROPER USE OF THE SKID-STEER LOADER AND ITS ATTACHMENTS ON THE PART OF THE OPERATOR CAN RESULT IN INJURIES. OBSERVE THE FOLLOWING SAFETY PRECAUTIONS AT ALL TIMES:

- 1. FOR SERVICING, THE LOADER SHOULD BE ON LEVEL TERRAIN, ENGINE STOPPED WITH THE WHEELS BLOCKED OR THE ENTIRE LOADER SOLIDLY SUPPORTED WITH THE WHEELS OFF THE GROUND BEFORE SERVICING ANY COMPONENT OF THE DRIVETRAIN.**
- 2. FOR SERVICING UNDER THE OPERATOR'S SEAT, RAISE THE SEAT AND PAN ASSEMBLY TO THE RAISED LATCHED POSITION AND SECURELY LATCH.**
- 3. DO NOT OPERATE THE LOADER UNLESS THE SEAT IS LATCHED IN THE OPERATE POSITION.**
- 4. DO NOT SERVICE THE LOADER WITH A RAISED BOOM UNLESS THE BOOM IS RESTING ON THE BOOM LOCK PINS.**
- 5. DO NOT SERVICE THE LOADER WITH THE ENGINE RUNNING UNLESS THE LOADER IS PROPERLY AND SECURELY SUPPORTED WITH ALL FOUR WHEELS OFF THE GROUND.**
- 6. USE CAUTION WHEN SERVICING THE UNIT AROUND MOVING PARTS.**
- 7. DO NOT TILT THE BOOM AND CAB WITHOUT PROPER INSTRUCTION.**
- 8. DO NOT TILT THE BOOM AND CAB WITHOUT USING THE PROPER CAB TILTING TOOL.**
- 9. REINSTALL ALL SHIELDS REMOVED FOR SERVICE.**
- 10. NEVER LOOSEN ANY HYDRAULIC CONNECTIONS BEFORE RELIEVING THE PRESSURE IN THE HYDRAULIC SYSTEM.**
- 11. WEAR EYE PROTECTION SUCH AS GOGGLES, ETC.**
- 12. WEAR EAR PROTECTION SUCH AS EARPLUGS, ETC. WHEN YOU FEEL THE NOISE LEVEL IS UNCOMFORTABLE.**
- 13. IF ANY SERVICING OR ADJUSTMENTS REQUIRE THE BATTERY TO BE DISCONNECTED, DISCONNECT THE (-) NEGATIVE GROUND CABLE.**
- 14. WHEN SERVICING ELECTRICAL COMPONENTS, DISCONNECT THE (-) NEGATIVE GROUND CABLE.**
- 15. IF THE ELECTRONIC INSTRUMENT CLUSTER (EIC) REQUIRES REMOVAL FROM THE DASH AREA OF THE SKID-STEER LOADER, DISCONNECT THE (-) NEGATIVE GROUND BATTERY CABLE. THIS WILL SHUT OFF POWER TO THE EIC AND PREVENT DAMAGE TO THE EIC BOARD OR BLOWING THE 5-AMP FUSES IF THE BOARD IS ACCIDENTALLY GROUNDED.**
- 16. IF WELDING IS REQUIRED ON THE SKID-STEER LOADER, DISCONNECT THE (-) NEGATIVE GROUND CABLE. FAILURE TO DISCONNECT THE BATTERY MAY RESULT IN DAMAGE TO THE EIC (ELECTRONIC INSTRUMENT CLUSTER) MONITORING SYSTEM AND OTHER ELECTRICAL COMPONENTS.**
- 17. IF WELDING IS REQUIRED ON AN ATTACHMENT, REMOVE THE ATTACHMENT FROM THE SKID-STEER LOADER.**

SECTION 1 - GENERAL INFORMATION

18. GIVE COMPLETE AND UNDIVIDED ATTENTION TO THE JOB AT HAND SO THAT COMPLETE CONTROL OF THE LOADER IS MAINTAINED AT ALL TIMES.
19. DRIVE SLOWLY OVER ROUGH GROUND AND ON SLOPES; KEEP ALERT FOR HOLES, DITCHES AND OTHER IRREGULARITIES THAT MAY CAUSE THE LOADER TO OVERTURN.
20. AVOID STEEP HILLSIDE OPERATION WHICH COULD CAUSE THE LOADER TO OVERTURN.
21. NEVER TRANSPORT A LOADED BUCKET AT FULL HEIGHT. OPERATE THE LOADER WITH THE LOAD AS LOW AS POSSIBLE UNTIL IT BECOMES NECESSARY TO RAISE THE BOOM TO DISCHARGE THE LOAD INTO A TRUCK, CONTAINER, ETC.
22. REDUCE SPEED WHEN TURNING SO THERE IS NO DANGER OF THE LOADER OVERTURNING.
23. NEVER DRIVE UP OR BACK UP A HILL OR INCLINE WITH A RAISED BOOM OR THE LOADER COULD OVERTURN.
24. ALWAYS LOOK BEHIND YOU BEFORE BACKING UP THE LOADER.
25. MAINTAIN PROPER TRANSMISSION OIL LEVEL TO PREVENT LOSS OF HYDROSTATIC BRAKING.
26. DO NOT ALLOW PASSENGERS TO RIDE ON THE LOADER AT ANY TIME.
27. DO NOT ALLOW CHILDREN TO OPERATE THE LOADER OR RIDE ON THE LOADER AT ANY TIME.
28. DO NOT ALLOW ANYONE TO OPERATE THE LOADER WITHOUT PROPER INSTRUCTION.
OSHA REQUIRES THAT ALL OPERATORS BE INSTRUCTED ON THE PROPER OPERATION OF THE MACHINE BEFORE THEY OPERATE THE UNIT.
29. DO NOT OPERATE THE LOADER IN ANY POSITION OTHER THAN WHILE IN THE OPERATOR'S SEAT WITH THE SEAT BELT SECURELY FASTENED.
30. BEFORE STARTING THE ENGINE, BE SURE THAT ALL OPERATING CONTROLS ARE IN NEUTRAL AND THE PARKING BRAKE IS ENGAGED.
31. NEVER OPERATE THE LOADER ENGINE IN A CLOSED BUILDING WITHOUT ADEQUATE VENTILATION.
32. REFUEL THE LOADER OUTDOORS WITH THE ENGINE SHUT OFF. REPLACE THE FUEL CAP SECURELY. USE AN APPROVED FUEL CONTAINER. DO NOT SMOKE WHEN HANDLING FUEL. AVOID SPILLING FUEL.
33. AFTER OPERATING THE ENGINE, NEVER TOUCH THE MUFFLER, EXHAUST PIPE, ENGINE OR RADIATOR UNTIL THEY HAVE HAD TIME TO COOL.
34. DRESS APPROPRIATELY - WEAR RELATIVELY TIGHT-FITTING CLOTHING WHEN OPERATING THE LOADER. LOOSE OR TORN CLOTHING CAN CATCH IN MOVING PARTS OR CONTROLS.
35. BEFORE SERVICING THE LOADER, OR ANY OF ITS ATTACHED EQUIPMENT, BE SURE THAT THE ATTACHMENTS ARE LOWERED TO THE GROUND OR THAT THE BOOM ARMS ARE SUPPORTED BY THE BOOM LOCK PINS.
36. DO NOT WORK UNDER OVERHANGS, ELECTRIC WIRES, OR WHERE THERE IS DANGER OF A SLIDE.

SECTION 1 - GENERAL INFORMATION

37. WEAR AN APPROVED SAFETY HAT WHEN OPERATING THE MACHINE AND WHILE IN ANY WORK AREA.
38. WHEN DRIVING THE LOADER ON A ROAD OR HIGHWAY, USE WARNING LIGHTS OR WARNING DEVICES AS MAY BE REQUIRED BY LOCAL OR STATE GOVERNMENT REGULATIONS. HEADLIGHTS, WARNING LIGHTS AND SMV SIGNS ARE AVAILABLE THROUGH YOUR NEW HOLLAND DEALER.
39. KEEP THE LOADER CLEAN. DO NOT ALLOW TRASH, DEBRIS OR OTHER ARTICLES TO ACCUMULATE IN THE CAB, FLOOR OR FOOT CONTROL PEDAL AREA THAT MAY HINDER SAFE MACHINE OPERATION.
40. NEVER OPERATE THE LOADER WITH ANY OF THE SHIELDING REMOVED.
41. NEVER OPERATE THE LOADER WITHOUT WINDOWS AND/OR SCREENS IN PLACE.
42. NEVER EXTEND ANY PART OF THE BODY OUTSIDE OF THE OPERATOR'S AREA.
43. ALWAYS PROPERLY TIE DOWN THE SKID-STEER LOADER TO A TRUCK OR TRAILER BEFORE TRANSPORT.
44. MAKE SURE ALL BYSTANDERS ARE AT A SAFE DISTANCE AWAY FROM THE LOADER BEFORE STARTING THE ENGINE.
45. DO NOT ALLOW ANYONE NEAR THE LOADER WHILE THE ENGINE IS RUNNING AND THE LOADER IS OPERATIONAL.
46. WHEN USING THE SKID-STEER LOADER TO CRANE OBJECTS, DO NOT ALLOW ANYONE TO RIDE ON OBJECTS BEING CRANED.
47. DO NOT USE THE SKID-STEER LOADER AS A WORK PLATFORM FOR SUPPORTING MATERIALS.
48. DO NOT LIFT PERSONNEL OR ALLOW PERSONNEL TO WORK WHILE STANDING IN THE BUCKET OR ON OTHER ATTACHMENTS. THIS IS NOT A MAN-LIFT.

OSHA REQUIREMENTS NOW MAKE IT THE EMPLOYER'S RESPONSIBILITY TO FULLY INSTRUCT EACH OPERATOR IN THE PROPER AND SAFE OPERATION OF ALL OPERATIVE EQUIPMENT. BOTH EMPLOYER AND EMPLOYEE SHOULD THOROUGHLY FAMILIARIZE THEMSELVES WITH THE FOLLOWING SECTIONS.



CAUTION!

SOME PICTURES IN THIS MANUAL SHOW SAFETY SHIELDS REMOVED OR OPEN TO SHOW PARTS BEING SERVICED OR FOR CLARITY. ALL SHIELDS SHOULD BE CLOSED OR REPLACED PRIOR TO OPERATING THE MACHINE.

DANGER!

FASTEN SEAT BELT

BEFORE STARTING ENGINE!

THIS LOADER IS A VERY STABLE UNIT BUT IT CAN BE UPSET IF STOPPED SUDDENLY WHEN THE BUCKET IS RAISED AND LOADED.

THEREFORE, DO NOT START THE ENGINE BEFORE SECURELY FASTENING THE SEAT BELT, AND CARRY THE LOAD LOW.

SAFETY DECALS

The following safety decals have been placed on your machine in the areas indicated. They are intended for the personal safety of you and those working with you. Please take this manual, walk around your machine and note the content and location of these warning signs. Review these

decals with your machine operators.

Keep the decals legible. If they are not, obtain replacements from your New Holland dealer. The decal part numbers are listed with each decal.

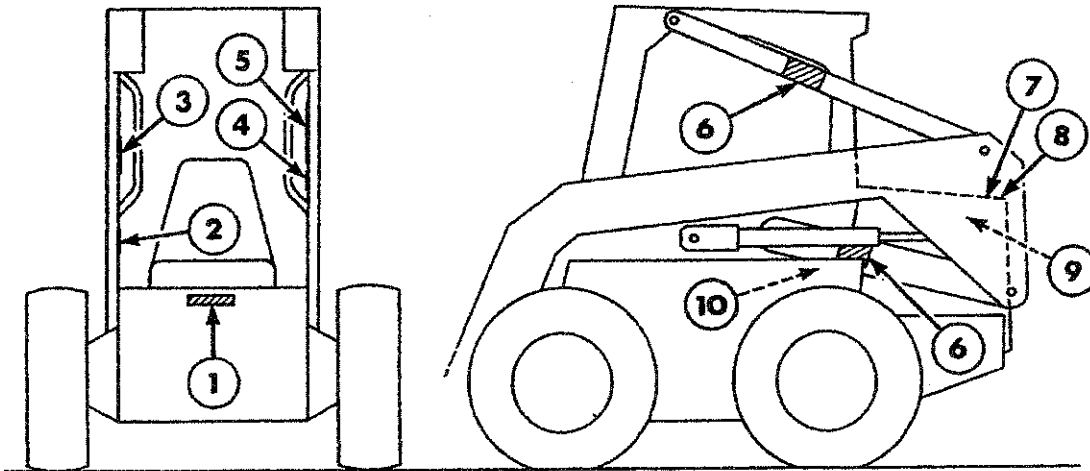

1. **DANGER: DO NOT ALLOW PASSENGERS TO RIDE ON THE LOADER AT ANY TIME.**

PART #86521685

<p>NO RIDERS</p>		<p>⚠ DANGER AVOID DEATH</p> <ul style="list-style-type: none"> ● LIFT ARM STOPS MUST BE ENGAGED ● OPENING LINES FOR SERVICE OR PART FAILURE CAN CAUSE LIFT ARMS TO DROP
-----------------------------	--	--

2. **CAUTION: DO NOT ALLOW ANYONE TO OPERATE THE LOADER WITHOUT PROPER INSTRUCTION.**

PART #86521688

<p>⚠ CAUTION AVOID INJURY</p> <ul style="list-style-type: none"> ● READ OPERATORS MANUAL ● KNOW LOCATION AND FUNCTION OF CONTROLS ● KEEP SAFETY DEVICES WORKING. ● KEEP SCREENS AND WINDOWS IN PLACE. ● KEEP CHILDREN AND OTHERS AWAY. ● NEVER CARRY RIDERS. ● LOWER LIFT ARMS, ENGAGE PARK BRAKE, STOP ENGINE AND REMOVE KEY BEFORE LEAVING. ● KEEP CAB CLEAN, ESPECIALLY PEDAL AREA.

3. **DANGER: BEFORE EXITING THE LOADER, LOWER THE LIFT ARMS AND ATTACHMENT TO THE GROUND OR REST LIFT ARMS ON THE BOOM STOPS. STOP ENGINE AND ENGAGE THE PARKING BRAKE.**

PART #86521683



4. **WARNING: DO NOT OVERLOAD! NEVER LIFT MORE THAN THE MAXIMUM SAE LOAD RATING OF THE LOADER. NEVER TRANSPORT A LOADED BUCKET AT FULL HEIGHT. OPERATE THE LOADER WITH THE LOAD AS LOW AS POSSIBLE.**

PART #86521714

L465, - 1250 LBS. (570 KG)
Lx465 (MFG. RATING)

PART #86521715

Lx485 - 1350 LBS. (600 KG)
(MFG. RATING)

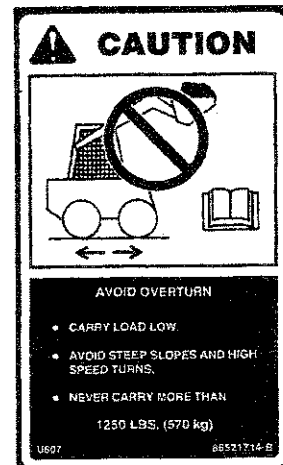

5. **WARNING: NEVER OPERATE THE LOADER WITHOUT THE SEAT BELT SECURELY FASTENED.**

PART #86521686

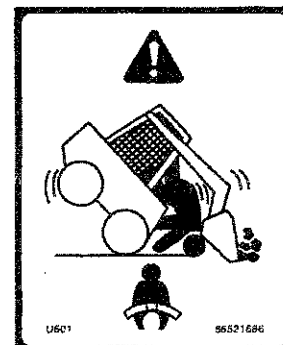

6. **WARNING: KEEP CLEAR OF MOVING PARTS. KEEP BYSTANDERS CLEAR OF THE LOADER AT ALL TIMES UNLESS THE BOOM IS DOWN ON THE GROUND OR THE BOOM IS RESTING ON THE BOOM LOCK PINS AND ENGINE IS OFF. NEVER EXTEND ANY PART OF THE BODY OUTSIDE OF THE OPERATOR'S AREA.**

PART #86521673

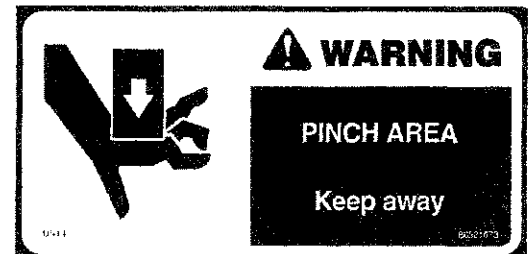

7. **WARNING: KEEP CLEAR! ROTATING FAN - STOP ENGINE.**

PART #9828825



8. **WARNING: DO NOT ALLOW ANYONE NEAR THE LOADER WHILE THE ENGINE IS RUNNING AND THE LOADER IS OPERATIONAL.**

PART #86509972

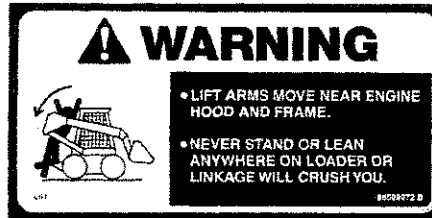

9. **CAUTION: DO NOT SPRAY ETHER INTO AIR INTAKE. EXPLOSION AND INJURY COULD RESULT.**

PART #786286



10. **DANGER: USE ONLY NEW HOLLAND CAB JACK KIT TO TILT CAB. READ INSTRUCTIONS BEFORE TILTING CAB. DO NOT REMOVE CAB HARDWARE BEFORE JACK IS INSTALLED. FAILURE TO DO SO MAY CAUSE CAB TO FALL CAUSING SERIOUS INJURY OR DEATH.**

PART #86521713

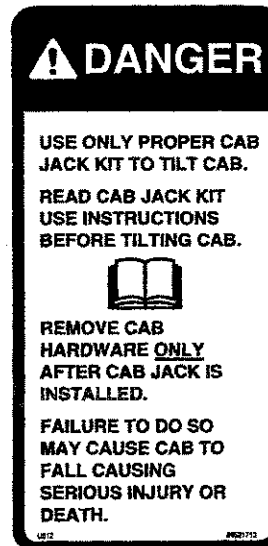

11. **DANGER: LOCATED ON THE CAB TILTING JACK. NEW HOLLAND SKID-STEER LOADER CAB TILTING TOOL. READ CAB TILTING INSTRUCTIONS AND USE WITH PROPER MOUNTING BRACKETS BEFORE TILTING CAB.**

PART #86508506

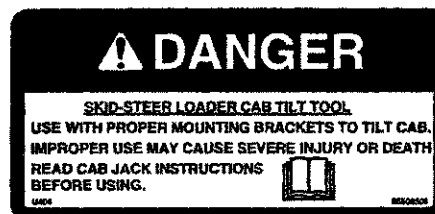

GENERAL SAFETY INFORMATION

HANDLE FLUIDS SAFELY

When you work around fuel or other flammable material, do not smoke or work near heaters or other fire hazards.

Do not store flammable material in open containers.

Store flammable fluids away from fire hazards.

Do not incinerate or puncture pressurized containers.

Make sure machine is clean of dirt, grease, oil, and debris.

Do not store oily rags; they can ignite and burn spontaneously.

Keep a first aid kit and fire extinguisher handy.

Keep emergency numbers for doctors, ambulance service, hospital, and fire department near your telephone.

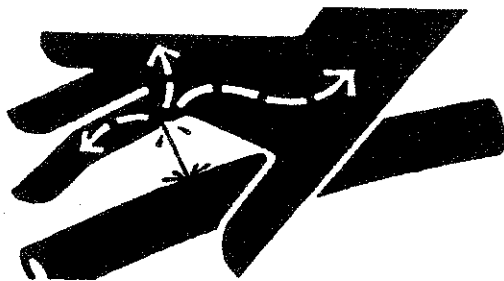

USE CARE AROUND HIGH-PRESSURE FLUID LINES

Escaping fluid under pressure can penetrate the skin causing serious injury.

Avoid the hazard by relieving pressure before disconnecting hydraulic or other lines.

Tighten all line connections before applying pressure.

Check for leaks with a piece of cardboard.

Protect hands and body from high-pressure fluids.

If an accident occurs, see a doctor immediately. Any fluid injected into the skin must be surgically removed within a few hours or gangrene may result. Doctors unfamiliar with this type of injury should reference a knowledgeable medical source.

AVOID HEATING NEAR PRESSURIZED FLUID LINES

Flammable spray can be generated by heating near pressurized fluid lines, resulting in severe burns to yourself and bystanders.

Do not heat by welding, soldering, or using a torch near pressurized fluid lines.

Pressurized lines can be accidentally cut or damaged when heat goes beyond the immediate flame area.

USE CARE IN HANDLING AND SERVICING BATTERIES

Prevent Battery Explosions

Keep sparks, lighted matches, and open flame away from the top of the battery. Battery gas can explode.

Never check battery charge by placing a metal object across the posts. Use a voltmeter or hydrometer.

Do not charge a frozen battery; it may explode. Warm the battery to 60° F (16° C).



WARNING: IF ANY SERVICING OR ADJUSTMENTS REQUIRE THE BATTERY TO BE DISCONNECTED, OR WELDING IS REQUIRED ON THE SKID-STEER LOADER, DISCONNECT THE (-) NEGATIVE GROUND CABLE. FAILURE TO DISCONNECT THE BATTERY MAY RESULT IN DAMAGE TO THE EIC (ELECTRONIC INSTRUMENT CLUSTER) MONITORING SYSTEM AND OTHER ELECTRICAL COMPONENTS.

WARNING: IF WELDING ON AN ATTACHMENT IS REQUIRED, FIRST REMOVE THE ATTACHMENT FROM THE LOADER BOOM ATTACHING PLATE.

WARNING: STARTING AN ENGINE WITH A BOOSTER BATTERY REQUIRES EXTREME CARE AS BATTERIES PRODUCE EXPLOSIVE GASES. THE SLIGHTEST SPARK CAN CAUSE AN EXPLOSION.

FOLLOW THESE SAFETY TIPS:

- 1. ALWAYS SHIELD YOUR EYES WHEN CHARGING OR WORKING NEAR A BATTERY. ALWAYS PROVIDE GOOD VENTILATION.**
- 2. COVER THE BATTERY WITH A PIECE OF CARPET OR OTHER HEAVY MATERIAL. DO NOT REMOVE THE BATTERY VENT CAPS.**
- 3. CONNECT ONE CABLE TO THE (+) POSITIVE TERMINAL OF THE WEAK BATTERY. CONNECT THE OTHER END OF THE CABLE TO THE (+) POSITIVE TERMINAL OF THE STRONGER BATTERY.**
- 4. CONNECT THE SECOND CABLE TO THE (-) NEGATIVE TERMINAL OF THE STRONGER BATTERY.**
- 5. CONNECT THE REMAINING (-) NEGATIVE CABLE END TO THE ENGINE BLOCK OR STARTER GROUND TERMINAL.**
- 6. REVERSE THIS PROCEDURE WHEN DISCONNECTING THE BOOSTER.**

USE SAFE SERVICE PROCEDURES

Wear Protective Clothing

Wear close-fitting clothing.

Wear safety glasses or face shield as required.

Wear other safety equipment appropriate to the job.

Wear earplugs or earmuffs as required.

SERVICE MACHINE SAFELY

Use caution when working around moving parts.

If servicing requires the boom to be in the raised position, remove any attachment from the boom mounting plate and support the boom on the boom lock pins. If servicing requires the complete loader to be in the supported position, support the unit with adequate jack stands or blocking with all four wheels off the ground.

If servicing requires the engine to be operated, raise the machine and properly support the unit with adequate jack stands or blocking with all four wheels off the ground.



CAUTION: BEFORE SERVICING THE LOADER OR ANY OF ITS ATTACHED EQUIPMENT, BE SURE THAT THE ATTACHMENTS ARE LOWERED TO THE GROUND OR THE BOOM ARMS ARE SUPPORTED BY THE BOOM LOCK PINS.

USE PROPER TOOLS

Use tools appropriate for the job.

If tilting of the cab is required, use the proper tools and follow the procedure for tilting the cab in Section 1 of this manual.

REVIEW SAFETY EQUIPMENT, SIGNS AND SHIELDS

Replace missing or damaged safety decals.

Reinstall all shielding removed for servicing.

Replace any damaged or missing shielding.

CONTROLS

Operate unit and check machine functions for proper operation.

Check seat belt for proper operation, wear, and damage - Replace as needed.

Check operator restraint system and EIC for proper operation.

Check boom and bucket spool locks for proper operation.

Check mechanical boom locks for proper operation.

Check parking brake for proper operation and adjustment.

MACHINE MODEL AND SERIAL NUMBER LOCATION

The skid-steer loader model and serial number tag is located on the right front interior of the operator's cab at 1.

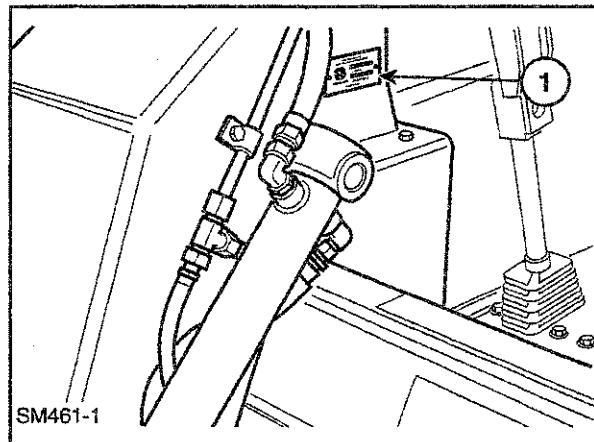

Figure 1-1

ENGINE MODEL AND SERIAL NUMBER LOCATION

The engine model and serial number is located on the left side of the block at 1.

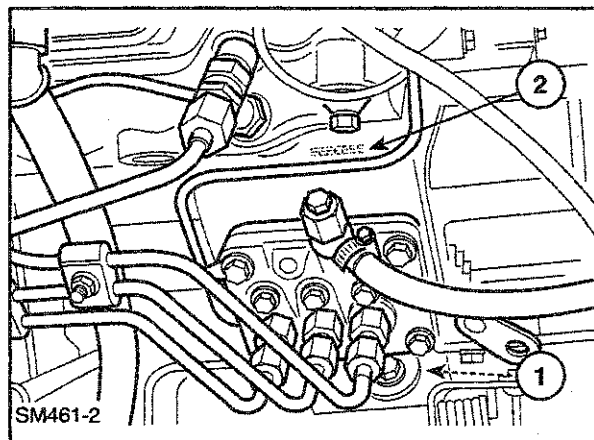

Figure 1-2

For the tightening torques for reassembly, use the following hardware torque chart unless the torque is specified in the instructions.

MINIMUM HARDWARE TIGHTENING TORQUES

IN FOOT POUNDS (NEWTON-METERS) FOR NORMAL ASSEMBLY APPLICATIONS

INCH HARDWARE AND LOCKNUTS

NOMINAL SIZE	SAE GRADE 2		SAE GRADE 5		SAE GRADE 8		LOCKNUTS		NOMINAL SIZE
	UNPLATED or PLATED SILVER	PLATED W/ZnCr GOLD	UNPLATED or PLATED SILVER	PLATED W/ZnCr GOLD	UNPLATED or PLATED SILVER	PLATED W/ZnCr GOLD	GR.B w/GR5 BOLT	GR.C w/GR8 BOLT	
1/4	55* (6.2)	72* (8.1)	86* (9.7)	112* (13)	121* (14)	157* (18)	61* (6.9)	86* (9.8)	1/4
5/16	115* (13)	149* (17)	178* (20)	229* (26)	250* (28)	324* (37)	125* (14)	176* (20)	5/16
3/8	17 (23)	22 (30)	26 (35)	34 (46)	37 (50)	48 (65)	19 (26)	26 (35)	3/8
7/16	27 (37)	35 (47)	42 (57)	54 (73)	59 (80)	77 (104)	30 (41)	42 (57)	7/16
1/2	42 (57)	54 (73)	64 (87)	83 (113)	91 (123)	117 (159)	45 (61)	64 (88)	1/2
9/16	60 (81)	77 (104)	92 (125)	120 (163)	130 (176)	169 (229)	65 (88)	92 (125)	9/16
5/8	83 (112)	107 (145)	128 (174)	165 (224)	180 (244)	233 (316)	90 (122)	127 (172)	5/8
3/4	146 (198)	189 (256)	226 (306)	293 (397)	319 (432)	413 (560)	160 (217)	226 (306)	3/4
7/8	142 (193)	183 (248)	365 (495)	473 (641)	515 (698)	667 (904)	258 (350)	364 (494)	7/8
1	213 (289)	275 (373)	547 (742)	708 (960)	773 (1048)	1000 (1356)	386 (523)	545 (739)	1

NOTE: Torque values shown with * are inch pounds.

IDENTIFICATION CAP SCREWS AND CARRIAGE BOLTS



SAE GRADE 2



SAE GRADE 5



SAE GRADE 8



REGULAR NUTS



SAE GRADE 5
HEX NUTS



SAE GRADE 8
HEX NUTS

LOCKNUTS

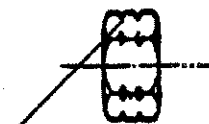

GRADE IDENTIFICATION
 GRADE A NO NOTCHES
 GRADE B ONE CIRCUMFERENTIAL NOTCH
 GRADE C TWO CIRCUMFERENTIAL NOTCHES



GRADE IDENTIFICATION
 GRADE A NO MARKS
 GRADE B THREE MARKS
 GRADE C SIX MARKS
 MARKS NEED NOT BE LOCATED
 AT CORNERS



GRADE IDENTIFICATION

GRADE A NO MARKS
 GRADE B LETTER B
 GRADE C LETTER C

MINIMUM HARDWARE TIGHTENING TORQUES

IN FOOT POUNDS (NEWTON-METERS) FOR NORMAL ASSEMBLY APPLICATIONS

METRIC HARDWARE AND LOCKNUTS

NOMINAL SIZE	CLASS 5.8		CLASS 8.8		CLASS 10.9		LOCKNUT CL.8 W/CL8.8 BOLT
	UNPLATED	PLATED W/ZnCr	UNPLATED	PLATED W/ZnCr	UNPLATED	PLATED W/ZnCr	
M4	15* (1.7)	19* (2.2)	23* (2.6)	30* (3.4)	33* (3.7)	42* (4.8)	16* (1.8)
M6	51* (5.8)	67* (7.6)	79* (8.9)	102* (12)	115* (13)	150* (17)	56* (6.3)
M8	124* (14)	159* (18)	195* (22)	248* (28)	274* (31)	354* (40)	133* (15)
M10	21 (28)	27 (36)	32 (43)	41 (56)	45 (61)	58 (79)	22 (30)
M12	36 (49)	46 (63)	55 (75)	72 (97)	79 (107)	102 (138)	39 (53)
M16	89 (121)	117 (158)	137 (186)	177 (240)	196 (266)	254 (344)	97 (131)
M20	175 (237)	226 (307)	277 (375)	358 (485)	383 (519)	495 (671)	195 (265)
M24	303 (411)	392 (531)	478 (648)	619 (839)	662 (897)	855 (1160)	338 (458)

NOTE: Torque values shown with * are inch pounds.

IDENTIFICATION HEX CAP SCREW AND CARRIAGE BOLTS CLASSES 5.6 AND UP

MANUFACTURER'S IDENTIFICATION

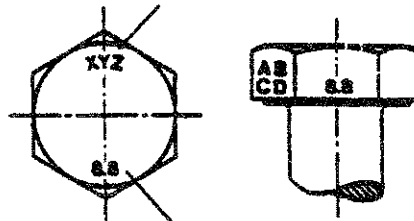

PROPERTY CLASS

HEX NUTS AND LOCKNUTS CLASSES 05 AND UP

MANUFACTURER'S IDENTIFICATION

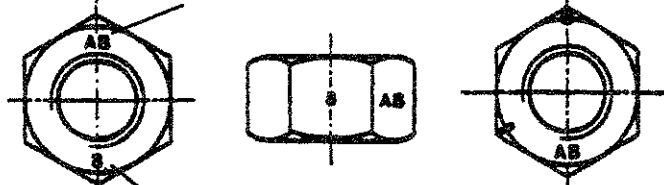

PROPERTY CLASS

CLOCK MARKING

INSTALLATION OF ADJUSTABLE FITTINGS IN STRAIGHT THREAD O RING BOSSES

1. Lubricate the O ring by coating it with a light oil or petroleum. Install the O ring in the groove adjacent to the metal backup washer which is assembled at the extreme end of the groove, 4.
2. Install the fitting into the SAE straight thread boss until the metal backup washer contacts the face of the boss, 5.

NOTE: Do not over tighten and distort the metal backup washer.

3. Position the fitting by turning out (counterclockwise) up to a maximum of one turn. Holding the pad of the fitting with a wrench, tighten the locknut and washer against the face of the boss, 6.

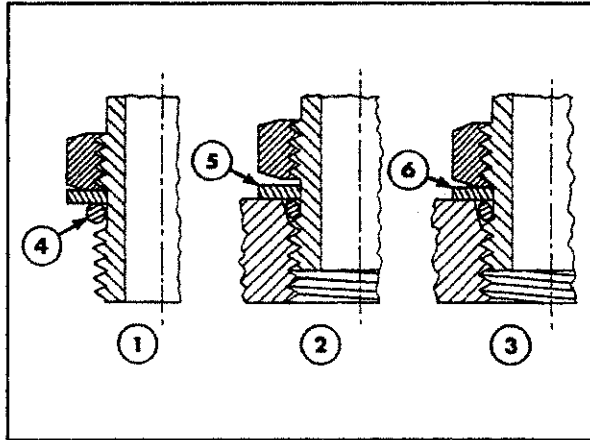

STANDARD TORQUE DATA FOR HYDRAULIC TUBES AND FITTINGS

TUBE NUTS FOR 37° FLARED FITTINGS					O RING BOSS PLUGS ADJUSTABLE FITTING LOCKNUTS, SWIVEL JIC - 37° SEATS						
SIZE	TUBING OD		THREAD SIZE	TORQUE		TORQUE		TORQUE		TORQUE	
	mm	In.		NEWTON METERS Min. Max.	FOOT POUNDS Min. Max.	NEWTON METERS Min. Max.	FOOT POUNDS Min. Max.	NEWTON METERS Min. Max.	FOOT POUNDS Min. Max.		
4	6.4	1/4	7/16-20	12	16	9	12	8	14	6	10
5	7.9	5/16	1/2-20	16	20	12	15	14	20	10	15
6	9.5	3/8	9/16-18	29	33	21	24	20	27	15	20
8	12.7	1/2	3/4-18	47	54	35	40	34	41	25	30
10	15.9	5/8	7/8-14	72	79	53	53	47	54	35	40
12	19.1	3/4	1-1/16-12	104	111	77	82	81	95	60	70
14	22.2	7/8	1-3/16-12	122	136	90	100	95	109	70	80
16	25.4	1	1-5/16-12	149	163	110	120	108	122	80	90
20	31.8	1-1/4	1-5/8-12	190	204	140	150	129	158	95	115
24	38.1	1-1/2	1-7/8-12	217	237	160	175	163	190	120	140
32	50.8	2	2-1/2-12	305	325	225	240	339	407	250	300

These torques are not recommended for tubes of 12.7 mm (1/2") OD and larger with wall thickness of 0.889 mm (0.035") or less. The torque is specified for 0.889 mm (0.035") wall tubes on each application individually.

Before installing and torquing 37° flared fittings, clean the face of the flare and threads with a

clean solvent or Loctite cleaner and apply hydraulic sealant Loctite no. 569 to the 37° flare and the threads.

Install fitting and torque to specified torque, loosen fitting and retorquing to specifications.

