

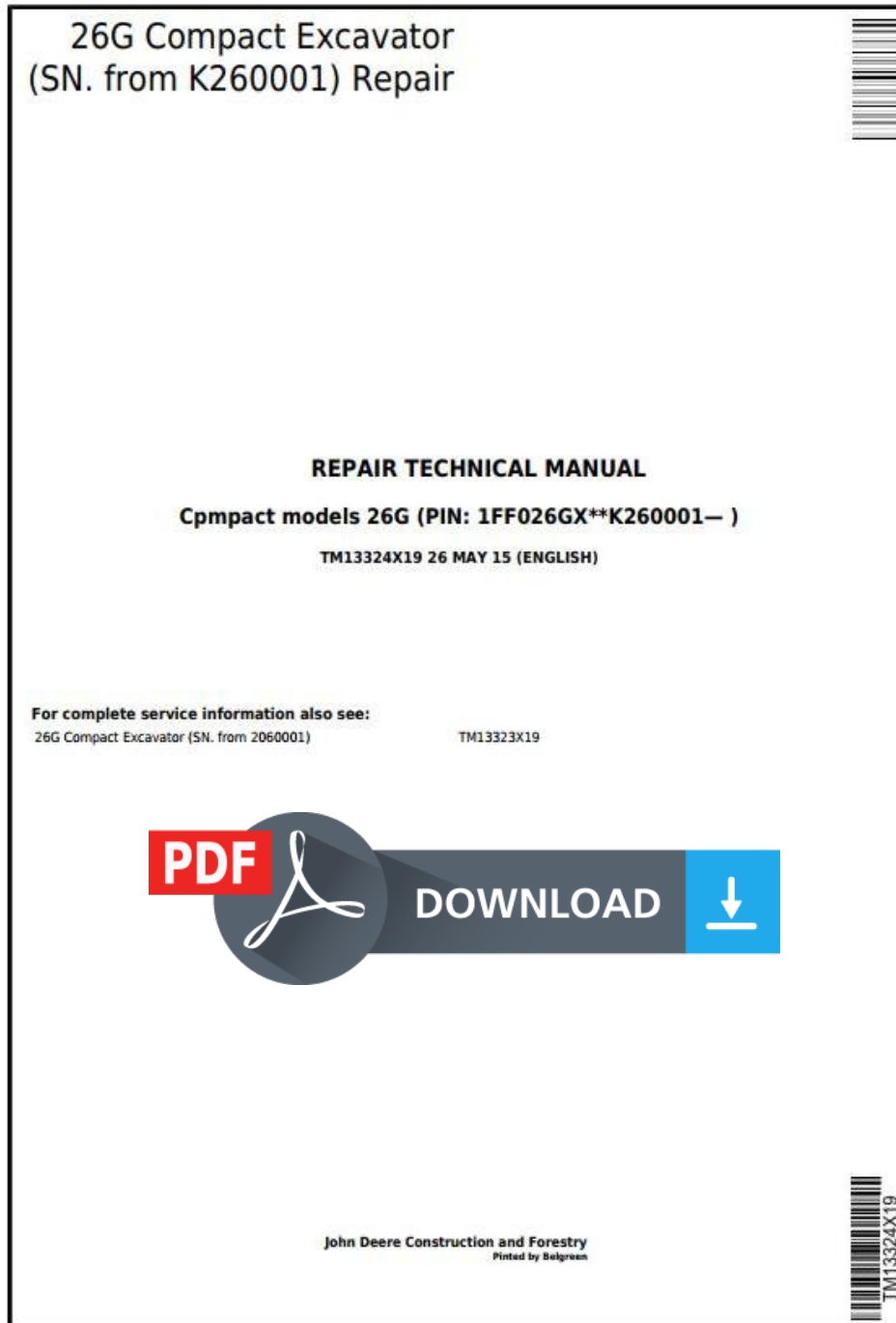







John Deere 26G (SN. from K260001) Compact Excavator Service Repair Technical Manual (TM13324X19)



Covers: 26G,1FF026GX**K260001       

Type: Service Manual

Language: English

Pages: 361

Format: PDF

Features: Bookmarked, searchable, printable

Compatibility: Windows/Mac/Tablet/Mobile

This service manual contains important information for the maintenance, troubleshooting and servicing of the **John Deere 26G (SN. from K260001) Compact Excavator Service Repair Technical Manual (TM13324X19)**

In this manual you will find detailed specifications, illustrations, schematics, diagrams and step-by-step procedures to properly service and diagnose the machine to the manufacturer's standards.

Contents:

- General Information
- Specifications
- Serial Number Location
- Engine Specifications
- Engine Diagnostics
- Engine Tests and Adjustments
- Engine Repair
- Power Train
- Transmission
- Axles
- Differential
- PTO
- Hydraulic System
- Electrical System
- Electrical Tests and Diagnostics
- Wiring Diagram / Schematic
- Ignition and Charging
- Steering
- Brakes
- Wheels
- Operator's Platform
- Body Panels
- Disassembly and Assembly
- Diagnostics, Tests and Adjustments
- Troubleshooting
- and much more...

Please note this manual is in **downloadable PDF format only**. If you have any questions about this product or would like to request sample pages, please contact us and reference the product name or SKU.

Travel Gear Case Disassemble and Assemble

Disassemble Travel Gear Case

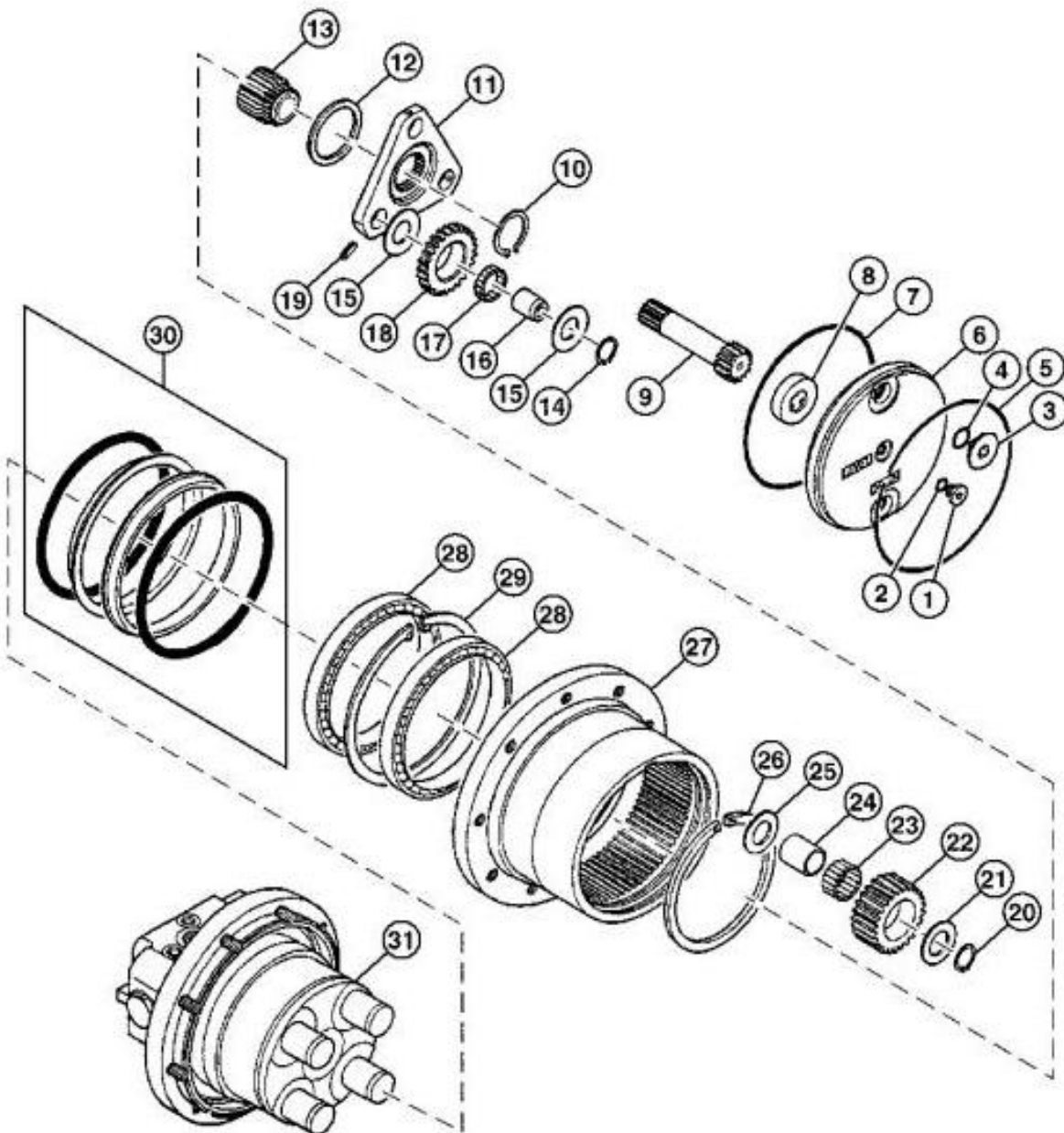

TX1135944

Travel Gear Case

LEGEND:

- | | |
|----|--------------------------------------|
| 1 | Check Plug |
| 2 | O-Ring |
| 3 | Plug (2 used) |
| 4 | O-Ring (2 used) |
| 5 | Wire Retainer |
| 6 | Cover |
| 7 | O-Ring |
| 8 | Thrust Ring |
| 9 | Input Shaft and First Stage Sun Gear |
| 10 | Snap Ring |
| 11 | First Stage Planetary Carrier |



Thank you very much
for your reading.
Please click here
to get more information.