

John Deere 6110M/20M 6130M/40M 6125M/35M 6145M/55M 6175M 6195M Tractors Diagnostic Manual (TM410619)



344G, 444G 4WD Loader
Diagnostic



OPERATION AND TEST MANUAL
4WD Loaders models 344G, 444G
TM1557 22 FEB 05 (ENGLISH)

For complete service information also see:

344G and 444G Loader Repair	TM1558
Series 300, 3029, 4039, 4045, 6059 and 6068 Diesel Engines	CTM8
Alternators and Starting Motors	CTM77
PowerTech 4.5L & 6.8L Diesel Engines Tier 1/Stage I, Tier 2/Stage II, Tier 3/Stage IIIA, Tier 3/Stage IIA, Tier 3/Stage IIB	CTM104

PDF  **DOWNLOAD** 

John Deere Construction and Forestry
Printed by Belgreen



TM1557

Covers: 6110M,6120M,6125M,6130M,6135M,6140M,6145M,6155M,6175M,6

Type: Service Manual

Language: English

Pages: 4160

Format: PDF

Features: Bookmarked, searchable, printable

Compatibility: Windows/Mac/Tablet/Mobile

This service manual contains important information for the maintenance, troubleshooting and servicing of the **John Deere 6110M/20M 6130M/40M 6125M/35M 6145M/55M 6175M 6195M Tractors Diagnostic Manual (TM410619)**

In this manual you will find detailed specifications, illustrations, schematics, diagrams and step-by-step procedures to properly service and diagnose the machine to the manufacturer's standards.

Contents:

- General Information
- Specifications
- Serial Number Location
- Engine Specifications
- Engine Diagnostics
- Engine Tests and Adjustments
- Engine Repair
- Power Train
- Transmission
- Axles
- Differential
- PTO
- Hydraulic System
- Electrical System
- Electrical Tests and Diagnostics
- Wiring Diagram / Schematic
- Ignition and Charging
- Steering
- Brakes
- Wheels
- Operator's Platform
- Body Panels
- Disassembly and Assembly
- Diagnostics, Tests and Adjustments
- Troubleshooting
- and much more...

Please note this manual is in **downloadable PDF format only**. If you have any questions about this product or would like to request sample pages, please contact us and reference the product name or SKU.

Cab Harness (W9) Component Location

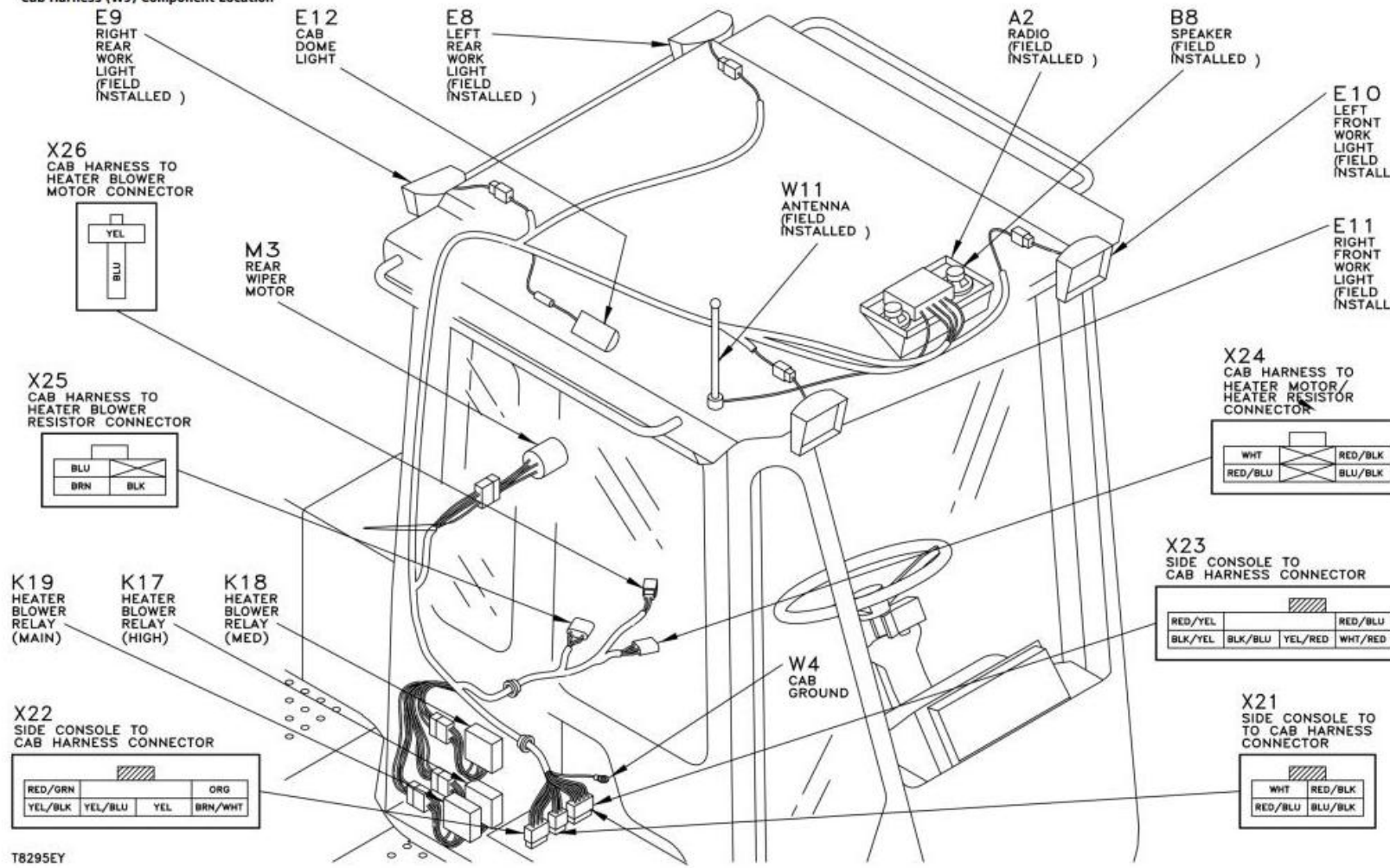

E9
RIGHT
REAR
WORK
LIGHT
(FIELD
INSTALLED)

E12
CAB
DOME
LIGHT

E8
LEFT
REAR
WORK
LIGHT
(FIELD
INSTALLED)

A2
RADIO
(FIELD
INSTALLED)

B8
SPEAKER
(FIELD
INSTALLED)

E10
LEFT
FRONT
WORK
LIGHT
(FIELD
INSTALL

E11
RIGHT
FRONT
WORK
LIGHT
(FIELD
INSTALL

X26
CAB HARNESS TO
HEATER BLOWER
MOTOR CONNECTOR

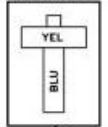

M3
REAR
WIPER
MOTOR

W11
ANTENNA
(FIELD
INSTALLED)

X25
CAB HARNESS TO
HEATER BLOWER
RESISTOR CONNECTOR

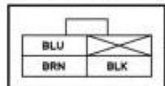

X24
CAB HARNESS TO
HEATER MOTOR/
HEATER RESISTOR
CONNECTOR

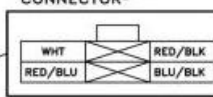

K19
HEATER
BLOWER
RELAY
(MAIN)

K17
HEATER
BLOWER
RELAY
(HIGH)

K18
HEATER
BLOWER
RELAY
(MED)

X23
SIDE CONSOLE TO
CAB HARNESS CONNECTOR

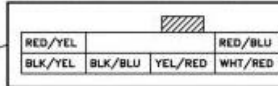

X22
SIDE CONSOLE TO
CAB HARNESS CONNECTOR

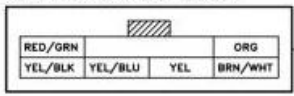

X21
SIDE CONSOLE TO
CAB HARNESS
CONNECTOR

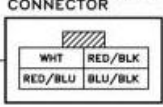

T8295EY

Cab Harness (W9) Component Location



Thank you very much
for your reading.
Please click here
to get more information.