

# John Deere 9540, 9560, 9580, 9640, 9660, 9680 CWS/WTS Combine Service Repair Technical Manual (tm4697)



344G, 444G 4WD Loader  
Diagnostic



**OPERATION AND TEST MANUAL**  
**4WD Loaders models 344G, 444G**  
TM1557 22 FEB 05 (ENGLISH)

**For complete service information also see:**

344G and 444G Loader Repair	TM1558
Series 300, 3029, 4039, 4045, 6059 and 6068 Diesel Engines	CTM8
Alternators and Starting Motors	CTM77
PowerTech 4.5L & 6.8L Diesel Engines Tier 1/Stage I, Tier 2/Stage II, Tier 3/Stage IIIA, Tier 3/Stage IIA, Tier 3/Stage IIB	CTM104

**PDF**  **DOWNLOAD** 

John Deere Construction and Forestry  
Printed by Belgreen



TM1557

**Covers:** 9540,9540,9640,9640,9580,9580,9680,9680,9660,9660,9560

**Type:** Service Manual

**Language:** English

**Pages:** 1351

**Format:** PDF

**Features:** Bookmarked, searchable, printable

**Compatibility:** Windows/Mac/Tablet/Mobile

This service manual contains important information for the maintenance, troubleshooting and servicing of the **John Deere 9540, 9560, 9580, 9640, 9660, 9680 CWS/WTS Combine Service Repair Technical Manual (tm4697)**

In this manual you will find detailed specifications, illustrations, schematics, diagrams and step-by-step procedures to properly service and diagnose the machine to the manufacturer's standards.

**Contents:**

- General Information
- Specifications
- Serial Number Location
- Engine Specifications
- Engine Diagnostics
- Engine Tests and Adjustments
- Engine Repair
- Power Train
- Transmission
- Axles
- Differential
- PTO
- Hydraulic System
- Electrical System
- Electrical Tests and Diagnostics
- Wiring Diagram / Schematic
- Ignition and Charging
- Steering
- Brakes
- Wheels
- Operator's Platform
- Body Panels
- Disassembly and Assembly
- Diagnostics, Tests and Adjustments
- Troubleshooting
- and much more...

Please note this manual is in **downloadable PDF format only**. If you have any questions about this product or would like to request sample pages, please contact us and reference the product name or SKU.

Cab Harness (W9) Component Location

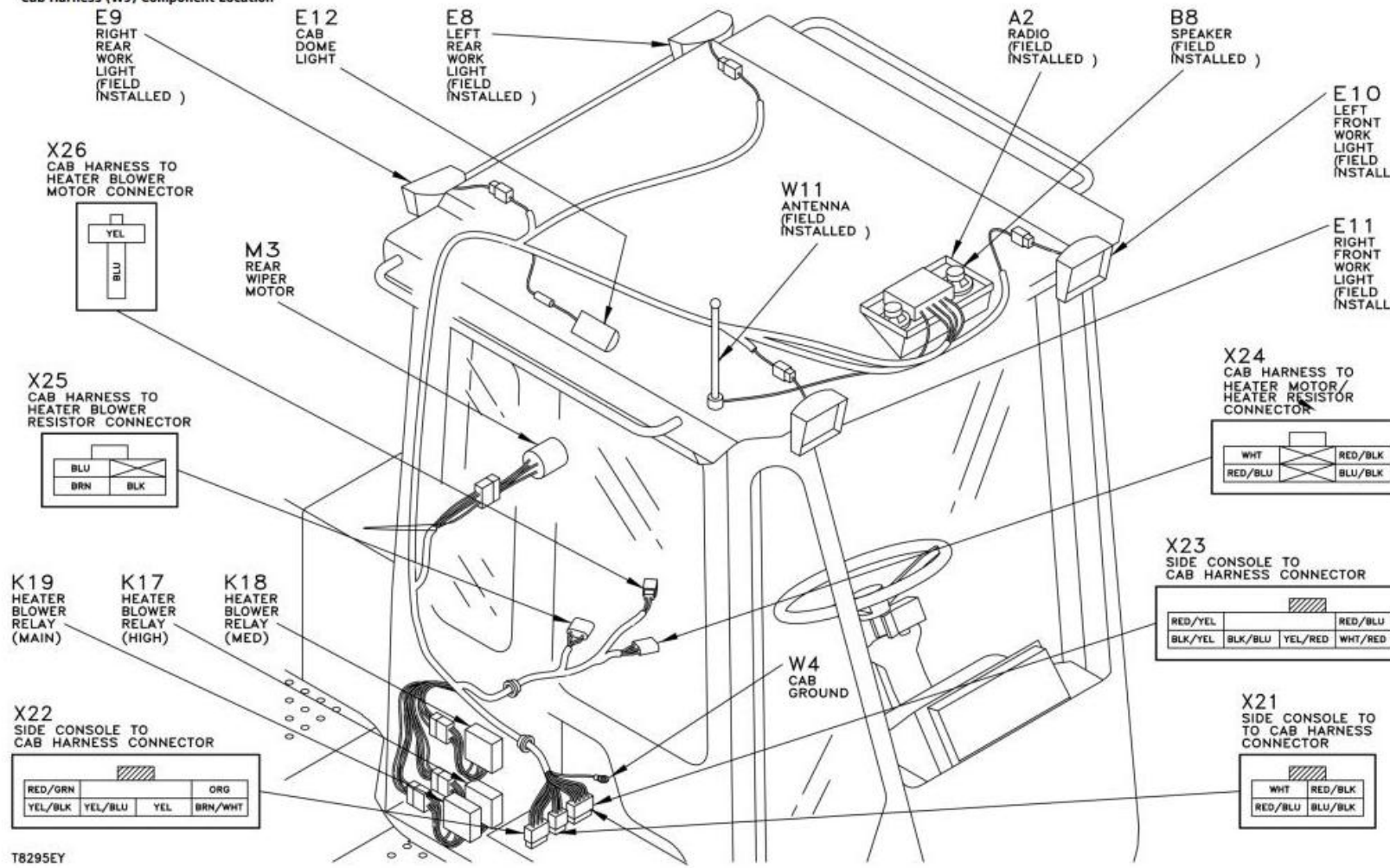

E9  
RIGHT  
REAR  
WORK  
LIGHT  
(FIELD  
INSTALLED )

E12  
CAB  
DOME  
LIGHT

E8  
LEFT  
REAR  
WORK  
LIGHT  
(FIELD  
INSTALLED )

A2  
RADIO  
(FIELD  
INSTALLED )

B8  
SPEAKER  
(FIELD  
INSTALLED )

E10  
LEFT  
FRONT  
WORK  
LIGHT  
(FIELD  
INSTALL

E11  
RIGHT  
FRONT  
WORK  
LIGHT  
(FIELD  
INSTALL

X26  
CAB HARNESS TO  
HEATER BLOWER  
MOTOR CONNECTOR

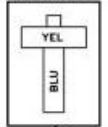

M3  
REAR  
WIPER  
MOTOR

W11  
ANTENNA  
(FIELD  
INSTALLED )

X25  
CAB HARNESS TO  
HEATER BLOWER  
RESISTOR CONNECTOR

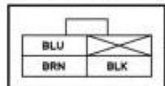

X24  
CAB HARNESS TO  
HEATER MOTOR/  
HEATER RESISTOR  
CONNECTOR

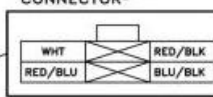

K19  
HEATER  
BLOWER  
RELAY  
(MAIN)

K17  
HEATER  
BLOWER  
RELAY  
(HIGH)

K18  
HEATER  
BLOWER  
RELAY  
(MED)

X23  
SIDE CONSOLE TO  
CAB HARNESS CONNECTOR

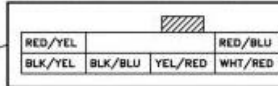

X22  
SIDE CONSOLE TO  
CAB HARNESS CONNECTOR

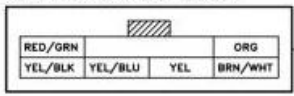

X21  
SIDE CONSOLE TO  
CAB HARNESS  
CONNECTOR

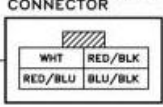

T8295EY

Cab Harness (W9) Component Location



Thank you very much  
for your reading.  
Please click here  
to get more information.