



# Bobcat®

---

## Operation & Maintenance Manual Forestry Cutter

---

(FRST CTRR FRC50) S/N ADTN00101 & Above  
(FRST CTRR FRC50) S/N ANR600101 & Above  
(FRST CTRR FRC50 2SPD) S/N ATSY00101 & Above  
(Forestry Cutter) S/N A6ZB00101 & Above  
(FRST CTRR FRC60) S/N ANR500101 & Above  
(FRST CTRR FRC60 2SPD) S/N ATV100101 & Above  
(FRST CTRR FRC70 2SPD) S/N B48D00101 & Above

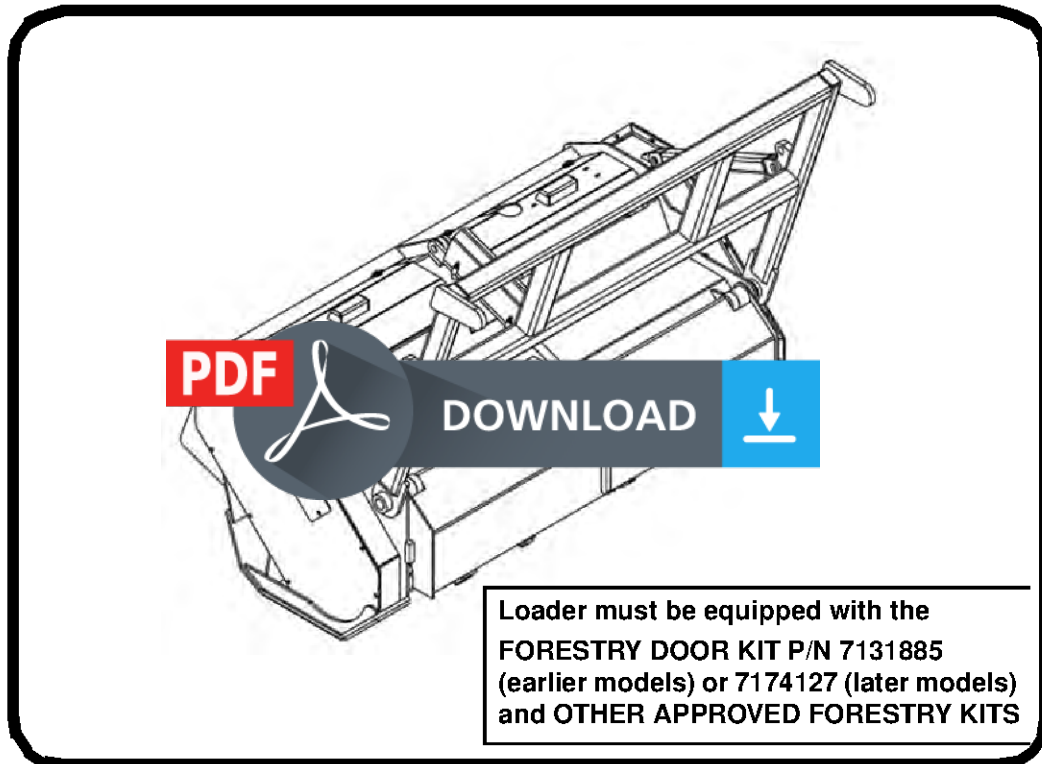

Forestry Cutter Maintenance  
Training DVD Included

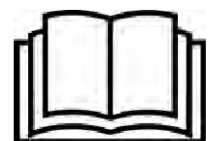



# OPERATOR SAFETY WARNINGS



## WARNING

Operator must have instructions before operating the machine. Untrained operators can cause injury or death.

W-2001-0502



**Safety Alert Symbol:** This symbol with a warning statement, means: "Warning, be alert! Your safety is involved!" Carefully read the message that follows.

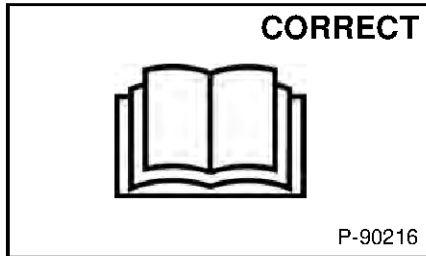

⚠ Never use the forestry cutter without instructions. See machine signs (decals), Operation & Maintenance Manual, Operator's Handbook and Maintenance Training Video.

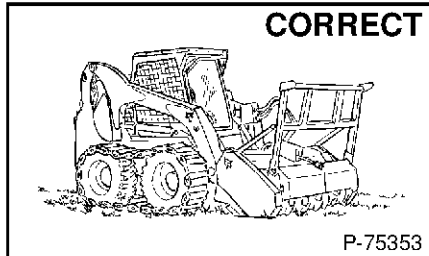

⚠ When servicing the forestry cutter always fully lower the lift arms, place the forestry cutter flat on the ground, engage the parking brake and stop the engine.

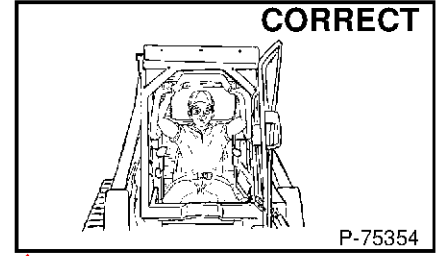

⚠ Always use the seat bar and fasten seat belt snugly.  
⚠ Always keep feet on the pedals when operating loader.

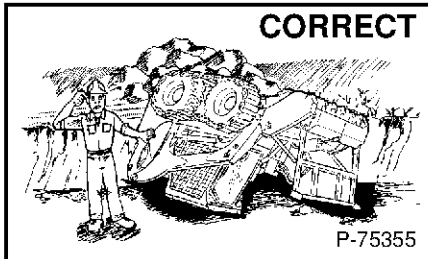

⚠ Always check work area before operating forestry cutter.  
⚠ Never use loader without operator cab with ROPS and FOPS approval. Fasten your seat belt.

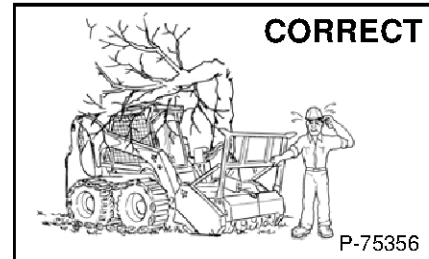

⚠ Do Not operate forestry cutter without a Level II FOPS kit installed on the cab of the loader.  
⚠ Do Not operate without forestry door installed.

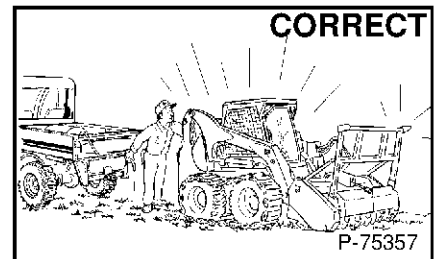

⚠ Flammable debris, can cause a fire hazard. Inspect the loader and forestry cutter and clean as necessary to avoid debris accumulation.

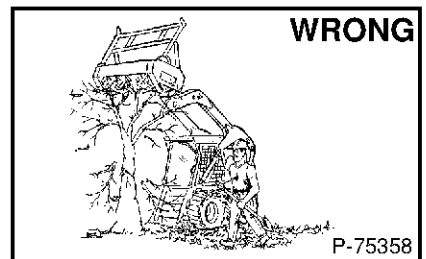

⚠ Keep bystanders away when operating forestry cutter.  
⚠ Never allow riders on forestry cutter.

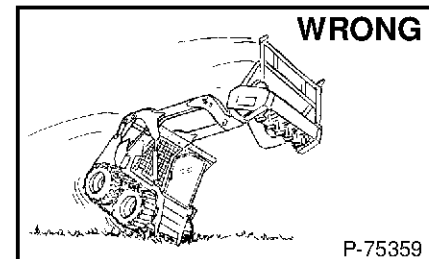

⚠ Always carry attachment as low as possible.  
⚠ Do not travel or turn with lift arms up.

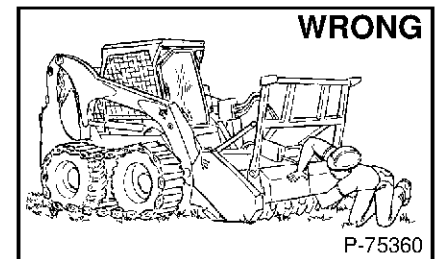

⚠ Do not put hands, feet, or objects under forestry cutter when engine is running.  
⚠ To park, engage parking brake and put attachment flat on the ground and stop engine.

## SAFETY EQUIPMENT

The Bobcat Loader and Forestry Cutter Attachment must be equipped with safety items necessary for each job. Ask your dealer about attachments and accessories.

1. SEAT BELT: Check belt fasteners and check for damaged webbing or buckle.
2. SEAT BAR: When up, it must lock the loader controls.
3. OPERATOR CAB (ROPS and FOPS): Must have Level II FOPS kit for use with Forestry Cutter attachment. Keep all fasteners tight.
4. OPERATOR'S HANDBOOK: Must be in the cab.
5. MACHINE AND ATTACHMENT SAFETY SIGNS (DECALS): Replace if damaged.
6. FORESTRY APPLICATIONS KIT: Required for additional operator and machine protection when using the Forestry Cutter attachment. Available from your dealer.
7. FORESTRY DOOR: Check for proper function of Interlock and Emergency Exit.
8. PARKING BRAKE:
9. GRAB HANDLES & SAFETY TREADS: Replace if damaged.
10. DEBRIS CHAINS: Replace if damaged.
11. FORESTRY CUTTER HYDRAULIC BRAKE: Check for proper function.

OSW54-0409



**Bobcat®**

# CONTENTS

FOREWORD .....	5
SAFETY & TRAINING RESOURCES .....	15
OPERATING INSTRUCTIONS .....	23
PREVENTIVE MAINTENANCE .....	71
MACHINE SIGN TRANSLATIONS .....	81
SPECIFICATIONS .....	89
WARRANTY .....	99
ALPHABETICAL INDEX .....	103

## REFERENCE INFORMATION

Write the correct information for YOUR Bobcat forestry cutter in the spaces below. Always use these numbers when referring to your Bobcat forestry cutter.

Forestry Cutter Serial Number \_\_\_\_\_  
\_\_\_\_\_

NOTES:

\_\_\_\_\_  
\_\_\_\_\_  
\_\_\_\_\_

YOUR BOBCAT DEALER:

ADDRESS:

PHONE:

Bobcat Company  
P.O. Box 128  
Gwinner, ND 58040-0128  
UNITED STATES OF AMERICA

Doosan Benelux SA  
Drève Richelle 167  
B-1410 Waterloo  
BELGIUM



Thank you very much  
for your reading.  
Please click here  
to get more information.