



Bobcat®

Service Manual

Three-Point Soil Conditioner

(3SC60H) S/N AH8P00101 & Above
(3SC60M) S/N AJKZ00101 & Above
(3SC72H) S/N AH8L00101 & Above
(3SC72M) S/N AJL400101 & Above

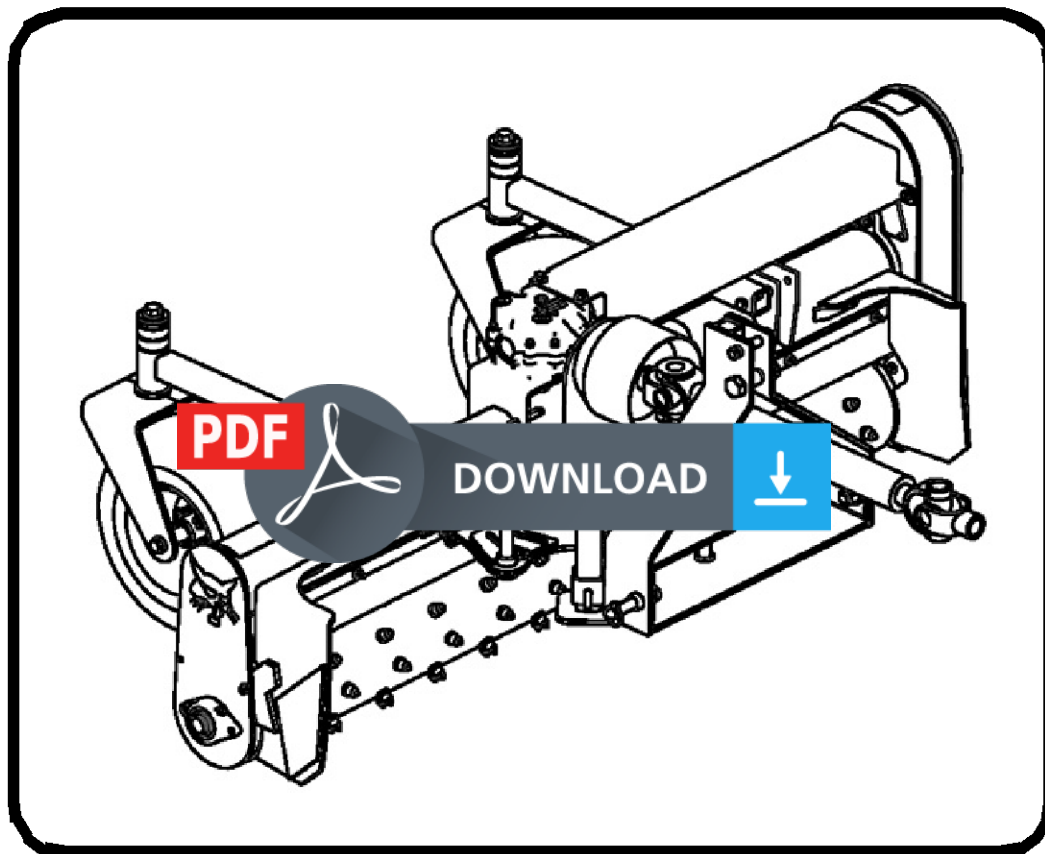

MAINTENANCE SAFETY



WARNING







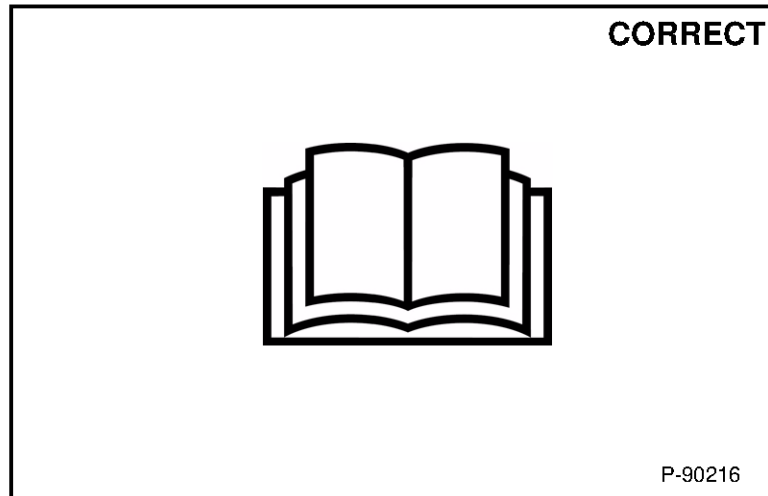

Instructions are necessary before operating or servicing machine. Read and understand the Operation & Maintenance Manual, Operator's Handbook and signs (decals) on machine. Follow warnings and instructions in the manuals when making repairs, adjustments or servicing. Check for correct function after adjustments, repairs or service. Untrained operators and failure to follow instructions can cause injury or death.

W-2003-0807



Safety Alert Symbol: This symbol with a warning statement, means: "Warning, be alert! Your safety is involved!" Carefully read the message that follows.



-  Never service attachments / implements without instructions. See Operation & Maintenance Manual and Attachment / Implement Service Manual.
-  Cleaning and maintenance are required daily.
-  Never service or adjust attachment / implement with the engine running unless instructed to do so in manual.
-  Always lower the attachment / implement to the ground before lubricating or servicing.
-  Avoid contact with leaking hydraulic fluid or diesel fuel under pressure. It can penetrate skin or eyes.
-  Stop, cool and clean engine of flammable materials before checking fluids.
-  Keep body, loose objects and clothing away from moving parts, electrical contacts, hot parts and exhaust.
-  Safety glasses are needed for eye protection from electrical arcs, battery acid, compressed springs, fluids under pressure and flying debris or when tools are used. Use eye protection approved for type of welding.



Bobcat®

ALPHABETICAL INDEX

(3SC60H, 3SC60M) THREE-POINT SOIL CONDITIONER SPECIFICATIONS . . .	SPEC-20-1
(3SC72H, 3SC72M) THREE-POINT SOIL CONDITIONER SPECIFICATIONS . . .	SPEC-20-3
BEARING	30-100-1
CASTER ARM	30-50-1
CHAIN CASE	30-80-1
DAILY INSPECTION	10-30-1
DELIVERY REPORT	III
END PLATE	30-10-1
GEARBOX	30-30-1
GUARD	30-110-1
HYDRAULIC CONNECTION SPECIFICATIONS	SPEC-30-1
HYDRAULIC CYLINDER (IF EQUIPPED)	20-10-1
IMPLEMENT IDENTIFICATION	IV
IMPLEMENT STORAGE AND RETURN TO SERVICE	10-40-1
LUBRICATING THE IMPLEMENT	10-60-1
MANUAL ANGLE ADJUST (IF EQUIPPED)	30-60-1
PIVOT	30-70-1
PTO DRIVELINE	30-20-1
REGULAR MAINTENANCE ITEMS	10-50-1
ROLLER	30-90-1
SCHEMATIC(S)	SPEC-10-1
SERIAL NUMBER LOCATION	III
SERVICE SCHEDULE	10-20-1
TORQUE SPECIFICATIONS FOR BOLTS	SPEC-40-1
TROUBLESHOOTING	10-10-1
WHEEL AXLE	30-40-1



Thank you very much
for your reading.
Please click here
to get more information.