

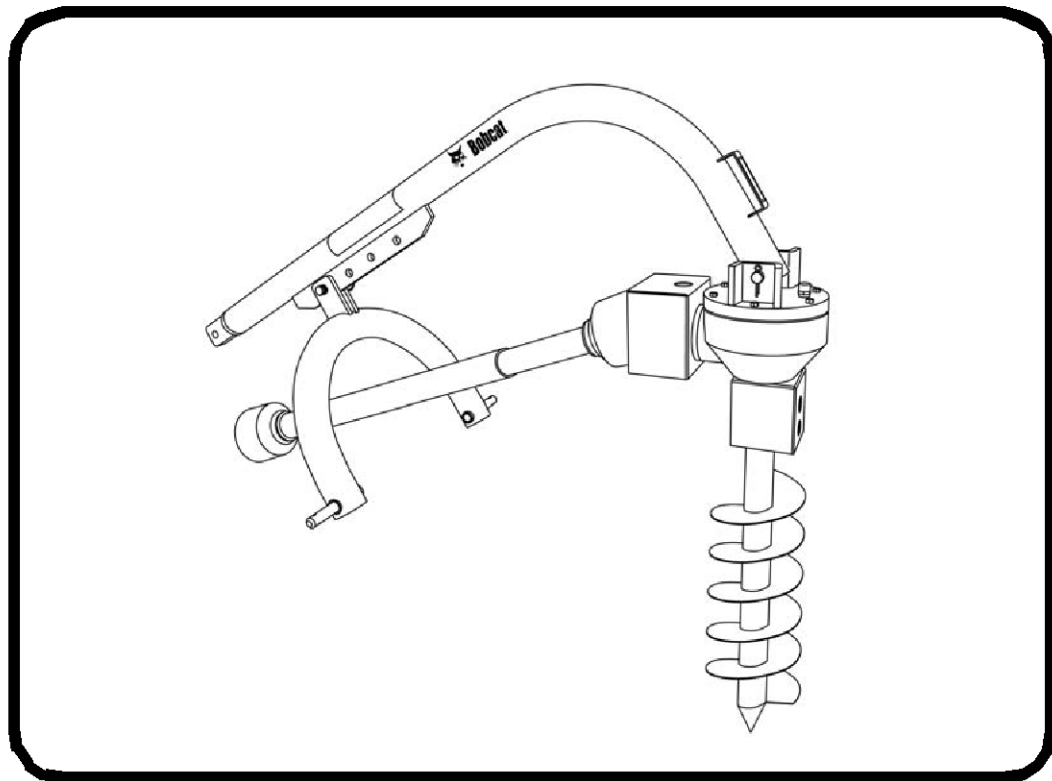

Bobcat®

Service Manual Three-Point Auger

(3PTA) S/N AMJS00101 & Above



MAINTENANCE SAFETY



WARNING







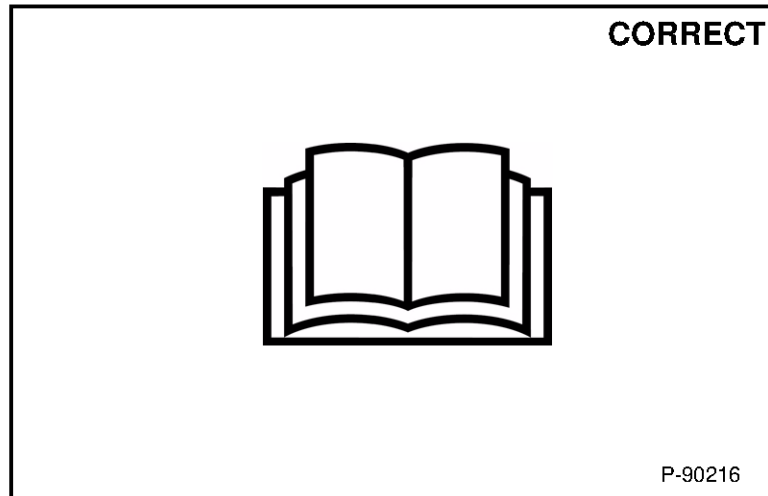

Instructions are necessary before operating or servicing machine. Read and understand the Operation & Maintenance Manual, Operator's Handbook and signs (decals) on machine. Follow warnings and instructions in the manuals when making repairs, adjustments or servicing. Check for correct function after adjustments, repairs or service. Untrained operators and failure to follow instructions can cause injury or death.

W-2003-0807



Safety Alert Symbol: This symbol with a warning statement, means: "Warning, be alert! Your safety is involved!" Carefully read the message that follows.



-  Never service attachments / implements without instructions. See Operation & Maintenance Manual and Attachment / Implement Service Manual.
-  Cleaning and maintenance are required daily.
-  Never service or adjust attachment / implement with the engine running unless instructed to do so in manual.
-  Always lower the attachment / implement to the ground before lubricating or servicing.
-  Avoid contact with leaking hydraulic fluid or diesel fuel under pressure. It can penetrate skin or eyes.
-  Stop, cool and clean engine of flammable materials before checking fluids.
-  Keep body, loose objects and clothing away from moving parts, electrical contacts, hot parts and exhaust.
-  Safety glasses are needed for eye protection from electrical arcs, battery acid, compressed springs, fluids under pressure and flying debris or when tools are used. Use eye protection approved for type of welding.



Bobcat®

CONTENTS

SAFETY & MAINTENANCE	10-01
MAINFRAME	20-01
SPECIFICATIONS	SPEC-01
ALPHABETICAL INDEX	INDEX-01



Bobcat®

FOREWORD

SERIAL NUMBER LOCATION	1-7
Implement Serial Number	1-7
DELIVERY REPORT	1-7
IMPLEMENT IDENTIFICATION	1-8



Bobcat®

SERIAL NUMBER LOCATION

Implement Serial Number

Figure 1

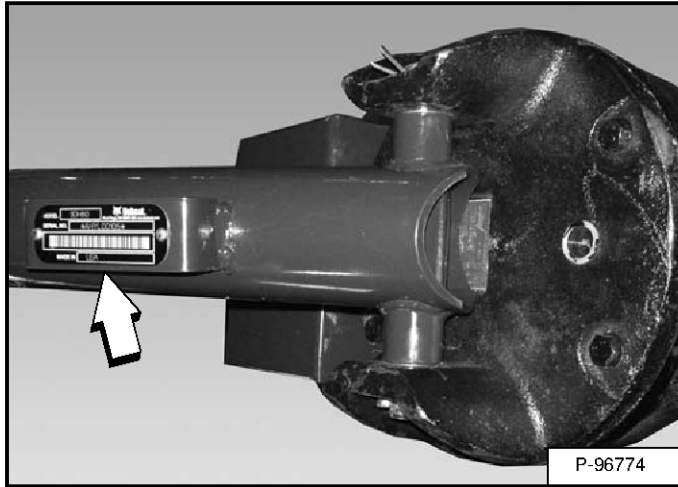

Always use the serial number of the three-point auger when requesting service information or when ordering parts. Early or later models (identification made by serial number) may use different parts, or it may be necessary to use a different procedure in doing a specific service operation [Figure 1].

DELIVERY REPORT

Figure 2

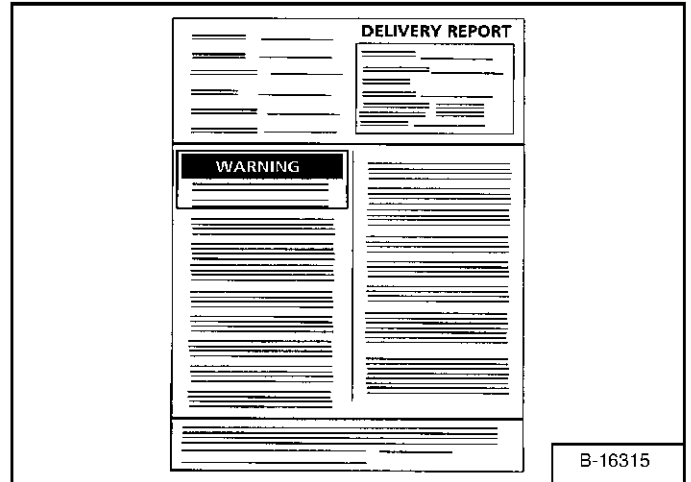

A form titled "DELIVERY REPORT" with a "WARNING" section. The form is divided into several sections with horizontal lines for text entry. The "WARNING" section is highlighted with a black background and white text. The reference code "B-16315" is located in the bottom right corner of the form.

The delivery report [Figure 2] must be completed by the dealer and signed by the owner or operator when the Bobcat three-point auger is delivered. An explanation of the form must be given to the owner.

IMPLEMENT IDENTIFICATION

LIGHT DUTY BIT
ADAPTER
(OPTIONAL)



P-96606

MAIN FRAME

UPPER
THREE-POINT
MOUNT

IMPLEMENT PTO
SHIELD

OUTPUT SHAFT
SHIELD

AUGER BIT

LOWER
THREE-POINT
MOUNT

PTO DRIVELINE

GEARBOX

P-96773

SAFETY & MAINTENANCE

TROUBLESHOOTING	10-10-1
Chart	10-10-1
LUBRICATING THE IMPLEMENT	10-20-1
Lubrication Locations	10-20-1
DAILY INSPECTION	10-30-1
Implement Mounting Frame	10-30-1
Three-Point Hitch	10-30-2
REGULAR MAINTENANCE ITEMS	10-40-1
Gearbox Lubricant	10-40-1
REMOVAL AND INSTALLATION OF AUGER TEETH	10-50-1
Procedure	10-50-1
IMPLEMENT STORAGE AND RETURN TO SERVICE	10-60-1
Storage	10-60-1
Return To Service	10-60-1



Bobcat®

TROUBLESHOOTING

Chart

 WARNING	<p>Instructions are necessary before operating or servicing machine. Read and understand the Operation & Maintenance Manual, Operator's Handbook and signs (decals) on machine. Follow warnings and instructions in the manuals when making repairs, adjustments or servicing. Check for correct function after adjustments, repairs or service. Untrained operators and failure to follow instructions can cause injury or death.</p> <p style="text-align: right;">W-2003-0903</p>
--	--

Use the following troubleshooting chart to locate and correct problems which most often occur with the implement.

PROBLEM	CAUSE	CORRECTION
Auger bit does not dig efficiently.	Worn or damaged auger teeth.	Replace teeth.
Auger bit does not rotate.	Worn or damaged key in gear box.	Replace key.
	Broken shear bolt.	Replace shear bolt.



Bobcat®

LUBRICATING THE IMPLEMENT

Lubrication Locations

IMPORTANT

Fluid such as engine oil, hydraulic fluid, coolants, grease, etc. must be disposed of in an environmentally safe manner. Some regulations require that certain spills and leaks on the ground must be cleaned in a specific manner. See local, state and federal regulations for the correct disposal.

I-2067-0499

Always use a good quality lithium based multi-purpose grease when lubricating the implement. Apply lubricant until extra grease shows.

Lubricate the following **every 10 hours** of operation.

Figure 10-20-1

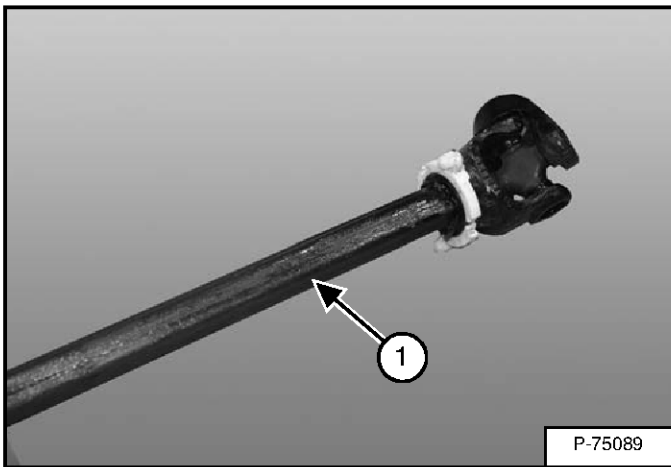

Apply grease to the PTO driveline (Item 1) [Figure 10-20-1].

Figure 10-20-2

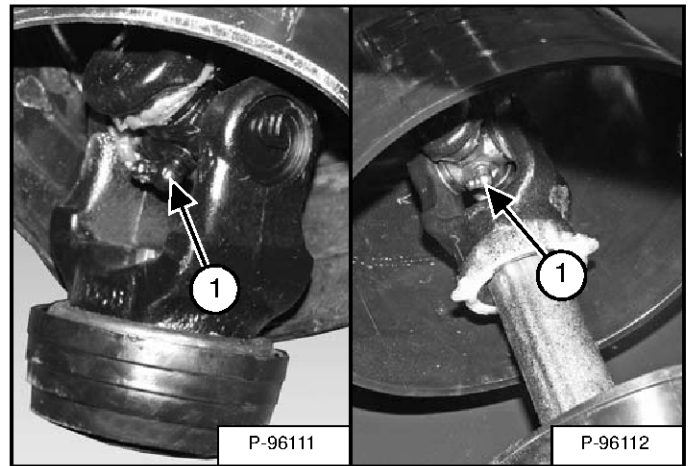

Lubricate the u-joint fittings (Item 1) [Figure 10-20-2] on both ends of the PTO driveline.

NOTE: If the telescoping parts of the driveline are allowed to become dirty or dry, the driveline will bind, greatly reducing the life of the U-joints and keep the auger bit from going into the ground smoothly.



Bobcat®

DAILY INSPECTION

Implement Mounting Frame

Figure 10-30-1

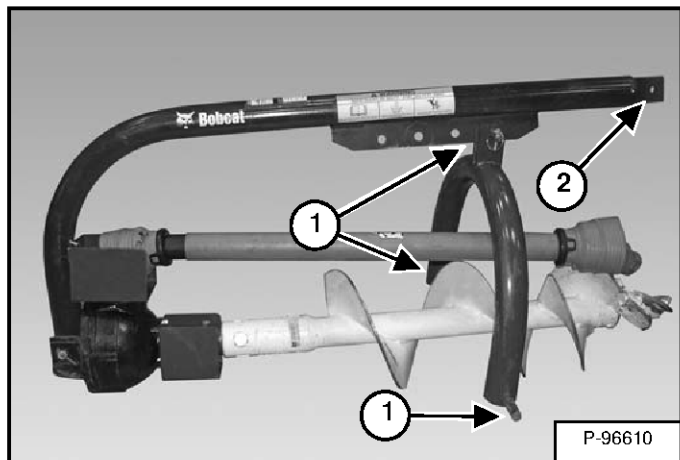

Inspect the lower three-point mounts (Item 1) and upper three-point mount (Item 2) [Figure 10-30-1] and all welds on the implement for wear and damage each time the implement is removed from the machine.

Frequently inspect the implement to ensure that all components are secure and that all bolts and nuts are thoroughly tightened.

Repair or replace damaged parts.

DAILY INSPECTION (CONT'D)

Three-Point Hitch

! WARNING

AVOID INJURY OR DEATH

- Disengage the PTO (rear and mid), engage the parking brake, stop the engine and make sure all rotating components are completely stopped before connecting, disconnecting, adjusting or cleaning any PTO driven equipment.
- Always keep PTO shields and all guards in place when using PTO driven equipment.
- Disengage PTO (rear and mid) for road travel.
- Keep hands, feet and clothing away.

W-2568-0907

! WARNING

AVOID INJURY OR DEATH

The parking brake must be engaged before leaving the operator's seat. Rollaway can occur because the transmission may not prevent machine movement. Lock the brake pedals together before activating the parking brake.

W-2656-0807

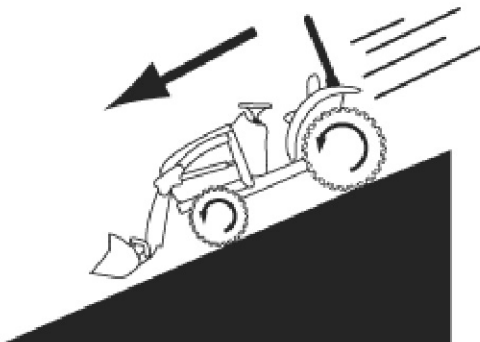

Figure 10-30-2

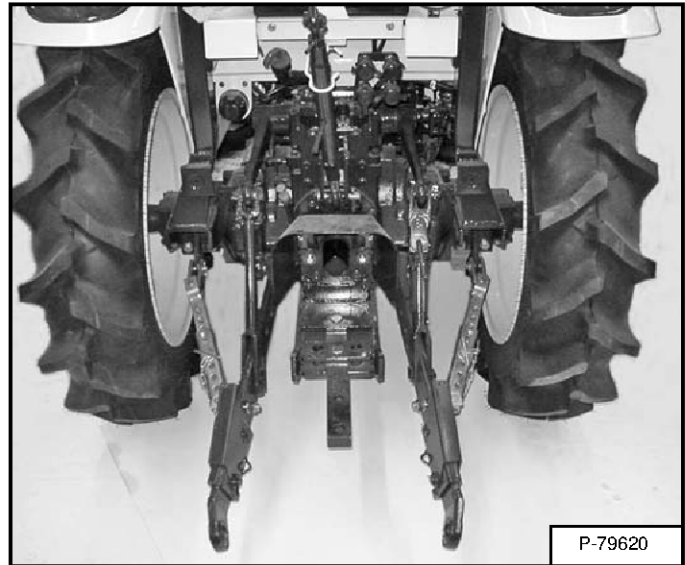
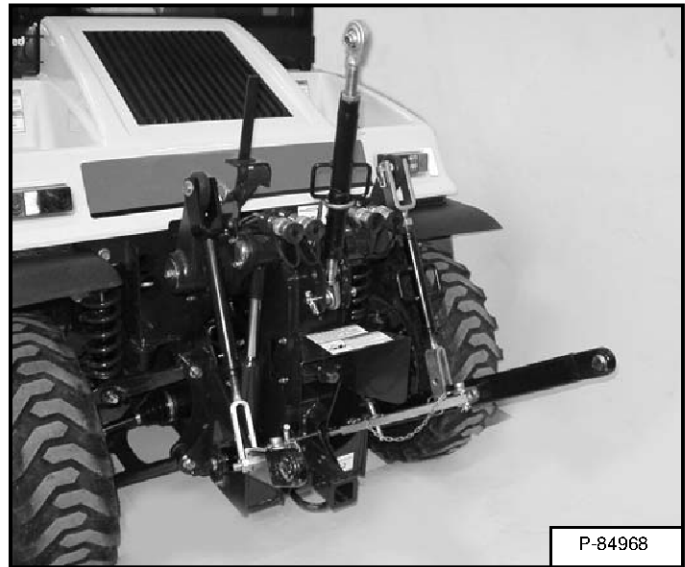

Figure 10-30-3



Inspect the three-point hitch linkage, PTO shaft splines, guards, and shields. Replace if damaged or missing [Figure 10-30-2] or [Figure 10-30-3]. Repair broken or loose parts.

See the machine's Operation & Maintenance Manual and Operator's Handbook for detailed information on inspecting three-point hitch.

REGULAR MAINTENANCE ITEMS

Gearbox Lubricant

WARNING

AVOID INJURY OR DEATH

Wear safety glasses to prevent eye injury when any of the following conditions exist:

- When fluids are under pressure.
- Flying debris or loose material is present.
- Engine is running.
- Tools are being used.

W-2019-0907

WARNING

AVOID INJURY OR DEATH

Securely block up the implement before working underneath.

W-2565-0207

Figure 10-40-1

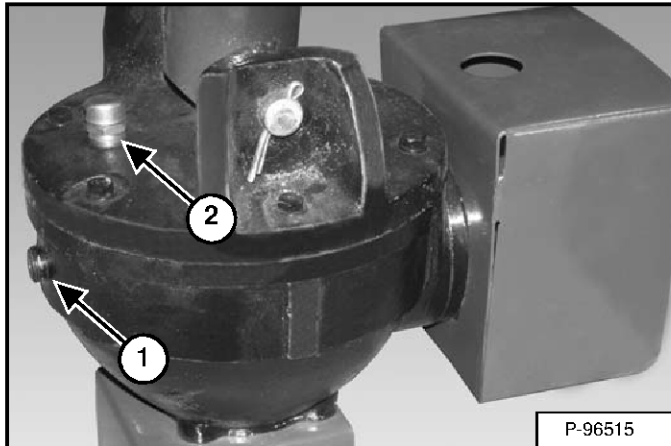

NOTE: When checking or adding oil, the gearbox must be level and the vent / fill plug hole facing upward.

Check for proper oil level in the gearbox **every 10 hours** of operation. Remove oil level plug (Item 1) [Figure 10-40-1]. If oil is level with oil level plug hole reinstall plug.

If oil is not level with oil level plug hole, remove vent / fill plug (Item 2) [Figure 10-40-1]. Add (80W-90 Gear Lube) until oil is level with oil level plug hole. Reinstall the plugs.



Bobcat[®]

