

KOMATSU PW210-1 Wheeled Excavators Service Repair Workshop Manual[SEBM020K0102]



SHOP MANUAL

KOMATSU

PW210-1

MACHINE MODEL SERIAL No.

PW210-1 10001 and up

- This shop manual may contain attachments and optional equipment that are not available in your area. Please consult your local Komatsu distributor for those items you may require. Materials and specifications are subject to change without notice.
- PW210-1 mount the S6D105-1 engine.
For details of the engine, see the 6D105 Series Engine Shop Manual.

CONTENTS

	No. of page
10 ENGINE	
11 STRUCTURE AND FUNCTION	11-1
12 TESTING AND ADJUSTING	12-1
13 DISASSEMBLY AND ASSEMBLY	13-1
20 POWER TRAIN	
21 STRUCTURE AND FUNCTION	21-1
23 DISASSEMBLY AND ASSEMBLY	23-1
24 MAINTENANCE STANDARD	24-1
40 STEERING SYSTEM	
41 STRUCTURE AND FUNCTION	41-1
42 TESTING AND ADJUSTING	42-1
43 DISASSEMBLY AND ASSEMBLY	43-1
44 MAINTENANCE STANDARD	44-1
50 AIR SYSTEM	
51 STRUCTURE AND FUNCTION	51-1
60 HYDRAULIC SYSTEM	
61 STRUCTURE AND FUNCTION	61-1
62 TESTING AND ADJUSTING	62-1
63 DISASSEMBLY AND ASSEMBLY	63-1
64 MAINTENANCE STANDARD	64-1
80 ELECTRIC AND ELETRONIC SYSTEM	
81 STRUCTURE AND FUNCTION	81-1
82 TESTING AND ADJUSTING	82-1

020K01

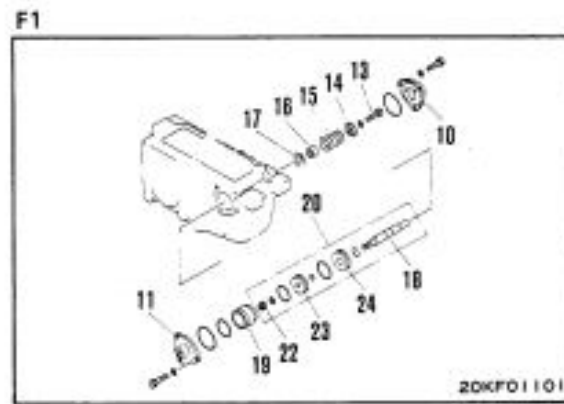
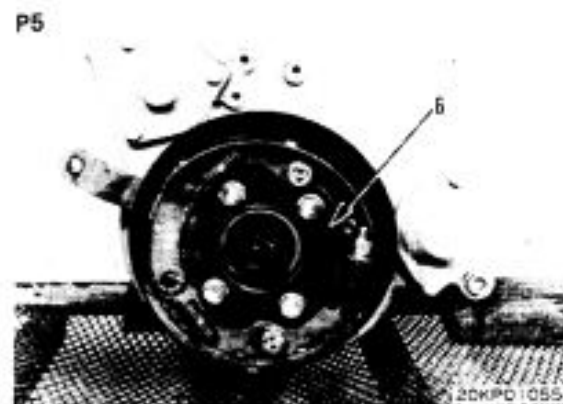
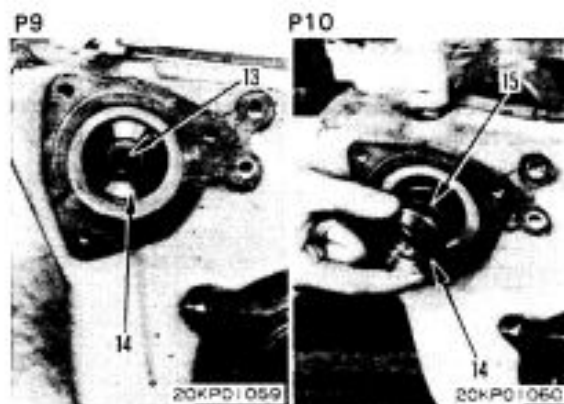
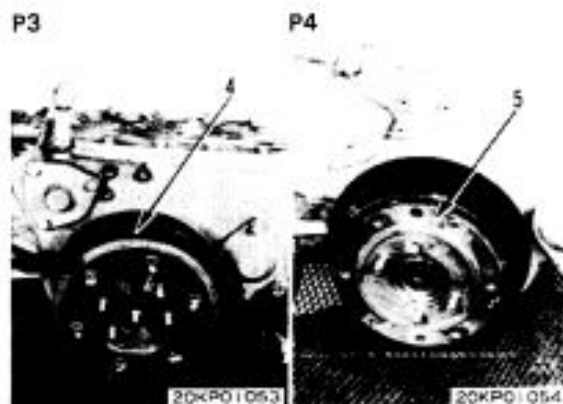
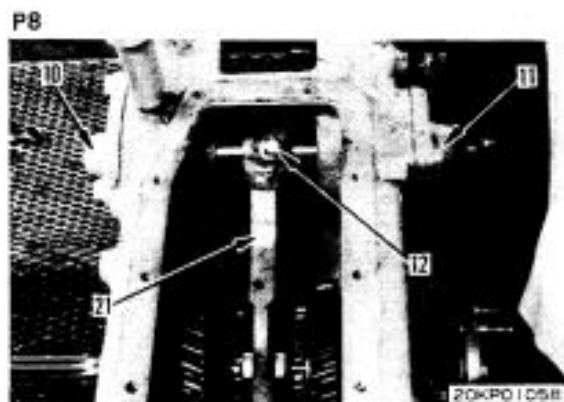
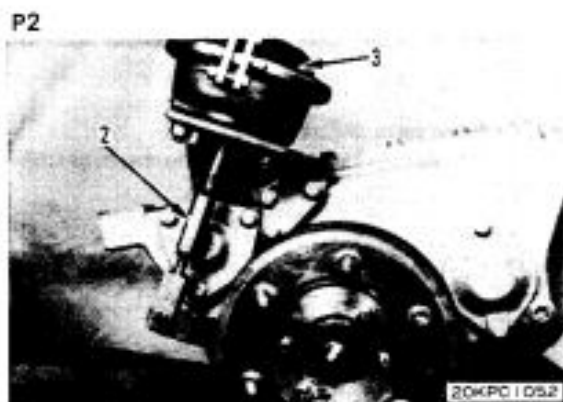
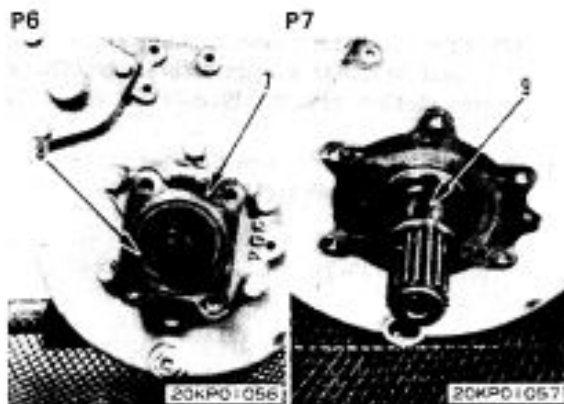



Thank you very much
for your reading.
Please click here
to get more information.